

NORTH AMERICAN RATED

North American Rated Devices

The Watertight Line. Superior Connection...Superior Protection

5100P7W

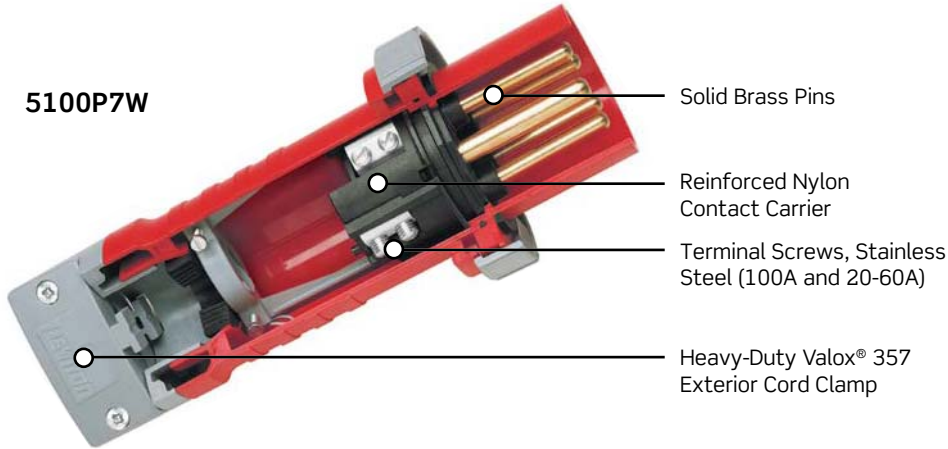

- Solid Brass Pins
- Reinforced Nylon Contact Carrier
- Terminal Screws, Stainless Steel (100A and 20-60A)
- Heavy-Duty Valox® 357 Exterior Cord Clamp



Accepts liquid-tight conduit with adapter accessory (**page G-15**)

5100C7W

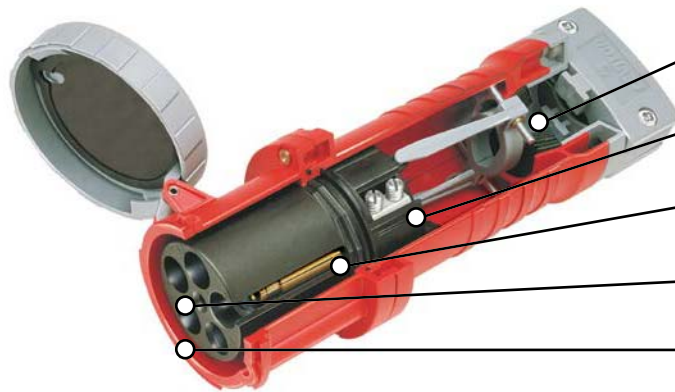

- Watertight Chloroprene Onion Skin Grommet
- Rear Terminals, Raised Lettering Identification
- Calibrated, Self-Adjusting Contacts
- Front Terminals, Raised Lettering Identification
- Super-Durable Valox® 357 Housing and external cord clamp

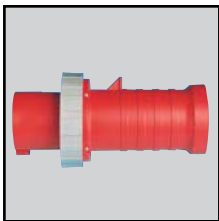

Super Tough Housing

- Provides maximum protection from abuse and environment
- Heavy-wall molding of Valox® 357 resists impact, heat, flame and chemicals
- Superior performance in low-to-high ambient temperature extremes (-40°C to 60°C)
- Excellent UV stability for superior outdoor performance (UL1682)
- V-0 flammability rating
- Fully insulated
- Color-coded by voltage for easy identification

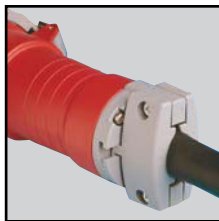

External Cord Clamp

- Protects terminals from strain
- Accommodates a wide variety of cord sizes
- Excellent impact strength
- Excellent UV stability for superior outdoor performance (UL1682)
- V-0 flammability rating
- Accepts wire mesh strain relief



Internal Cord Clamp

- Secondary method for eliminating strain on terminals and conductors
- True IEC 60309-1 & 60309-2 acceptance
- Constructed of sturdy thermoplastic for tough environments
- Removes easily for user convenience



Spring Loaded Cover, Cover Arm, & Locking Rings

- Rings lock plug to connector
- Spring loaded cover closes automatically
- "Performance grade" Stainless Steel cover spring for superior corrosion-resistance and long life
- Excellent UV stability for outdoor use
- V-0 flammability rating
- Interior arm design in 60 and 100 amp helps eliminate breakage



Gasket/Grommet

- Prevents moisture, dust, and contaminants from entering housing or pin/contact carrier
- Solid chloroprene for positive seal and excellent chemical/corrosion-resistance
- Onion skin design on grommet provides precise watertight fit, eliminating the need to choose from multiple grommets that may not fit the cable jacket precisely

Valox® is a registered trademark of SABIC

Features and Benefits

- Rugged housing, made of superior performance Valox® 357, provides maximum corrosion protection and makes the device more resistant to impact, abuse and temperature extremes. V-0 flame rated and superior UV stability
- Contact carrier resists arcing and internal heat build up; 60A and 100A contact/pin carriers are made of reinforced nylon for even greater strength and temperature resistance
- Zinc-coated steel terminal screws on 20A and 30A devices
- Brass terminal screws on 60A devices
- Dependable, clean brass construction for long life, reliable electrical contact, maximum conductivity, and corrosion resistance
- Watertight chloroprene onion skin grommet provides a precise, reliable seal at the cable entry point
- Ground, neutral and phase terminals are clearly identified by color coding or letters and numbering on both front and back sides
- Multiple contact points assure a continuously reliable electrical connection
- Engineered to IP67 watertight and IP69K high-pressure, high-temperature washdown standards
- North American Rated Devices 20A, 30A, 60A and 100A
- Meets North American IEC 60309-1 and 60309-2 Standards
- UL Rated for both 50Hz and 60Hz applications
- Rockwell Automation Encompass™ Product Partner
- Backed by a limited 2-year warranty

Pin & Contact Carrier, 60 & 100 Amp

- Protects pins and contacts, holding them firmly in place
- Pin carrier and contact carrier constructed of glass fiber reinforced nylon for maximum impact resistance and maximum protection of pins and contacts
- Superior arc-tracking resistance
- Excellent heat-resistance and flame resistance
- Chamfered wire entry makes wiring easier

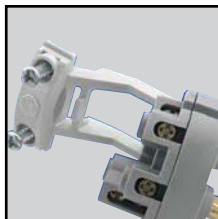
Pin & Contact Carrier, 20 & 30 Amp

- Pin carrier and contact carrier constructed of nylon for maximum impact resistance and maximum protection of pins and contacts
- Terminal screws are aligned on a single plane for easier access
- Internal hinged cord clamp adds strain-relief and swings aside when wiring terminals
- Large diameter combination head terminal screws

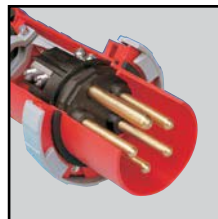
Pins

- Designed for manageable insertion/withdrawal force
- Clean brass construction resists corrosion, provides superior contact and low electrical resistance
- Rounded tips reduce insertion force and decrease wear on the contact surface area

Sleeves (Contacts)

- Designed for manageable insertion/withdrawal force
- Clean brass construction resists corrosion, provides superior contact and low electrical resistance
- Self-adjusting, machine-calibrated contacts for accurate contact pressure designed for superior wiping and cleaning action
- Made from high performance Swedish Industrial Standard (SIS) Brass 5170-04
- Positioned at sleeve entrance, stainless steel spring enables pin cleaning at earliest point of entry

Terminal Screws

- Engineered to provide maximum holding power and lowest electrical resistance
- Accepts a wide range of conductors
- Double screws ensure secure connection
- Direct bearing pressure terminals for 20, 30 and 60 Amp ratings; pressure clamp termination for 100 Amp devices

NORTH AMERICAN RATED | 60A and 100A Watertight
60A and 100A Watertight Pin & Sleeve Devices — North American Rated

Plug — 4100P12W



Connector — 4100C12W



Receptacle — 360R6W



Inlet — 360B7W



Back Box — BX100-V

Features and Benefits

- Engineered to IP67 watertight and IP69K high-pressure, high-temperature washdown standards
- Meet North American IEC 60309-1 and 60309-2 Standards
- Backed by a limited 2-year warranty

60A and 100A Watertight Pin & Sleeve Devices

Amps	Wiring	Voltage AC	Color	Connector/ Receptacle	Plug/ Inlet	Cat. No. Plug	Cat. No. Connector	Cat. No. Receptacle	Cat. No. Inlet	Cat. No. Back Box
60	2p3w	125	Yellow			360P4W	360C4W	360R4W	360B4W	BX60-V
	2p3w	250	Blue			360P6W	360C6W	360R6W	360B6W	BX60-V
	2p3w	480	Red			360P7W	360C7W	360R7W	360B7W	BX60-V
	3p4w	125/250	Orange			460P12W	460C12W	460R12W	460B12W	BX60-V
	3p4w	3Ø250	Blue			460P9W	460C9W	460R9W	460B9W	BX60-V
	3p4w	3Ø480	Red			460P7W	460C7W	460R7W	460B7W	BX60-V
	3p4w	3Ø600	Black			460P5W	460C5W	460R5W	460B5W	BX60-V
	4p5w	3ØY120/208	Blue			560P9W	560C9W	560R9W	560B9W	BX60-V
	4p5w	3ØY277/480	Red			560P7W	560C7W	560R7W	560B7W	BX60-V
4p5w	3ØY347/600	Black			560P5W	560C5W	560R5W	560B5W	BX60-V	
100	2p3w	125	Yellow			3100P4W	3100C4W	3100R4W	3100B4W	BX100-V
	2p3w	250	Blue			3100P6W	3100C6W	3100R6W	3100B6W	BX100-V
	2p3w	480	Red			3100P7W	3100C7W	3100R7W	3100B7W	BX100-V
	3p4w	125/250	Orange			4100P12W	4100C12W	4100R12W	4100B12W	BX100-V
	3p4w	3Ø250	Blue			4100P9W	4100C9W	4100R9W	4100B9W	BX100-V
	3p4w	3Ø480	Red			4100P7W	4100C7W	4100R7W	4100B7W	BX100-V
	3p4w	3Ø600	Black			4100P5W	4100C5W	4100R5W	4100B5W	BX100-V
	4p5w	3ØY120/208	Blue			5100P9W	5100C9W	5100R9W	5100B9W	BX100-V
	4p5w	3ØY277/480	Red			5100P7W	5100C7W	5100R7W	5100B7W	BX100-V
	4p5w	3ØY347/600	Black			5100P5W	5100C5W	5100R5W	5100B5W	BX100-V

NORTH AMERICAN RATED | Dimensions

Plugs — North American Rated

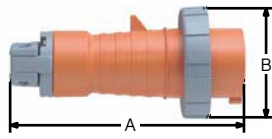

20A, 30A Plug

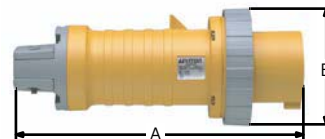

60A, 100A Plug

Dimensions for Plugs

Cat. No.	Amps	Unit (inches)		Unit (mm)		Cord Grip Range (Inches)	Cord Grip Range (mm)
		A	B	A	B		
320P	20	5.83	2.80	148	71	0.350 -0.860	9 - 22
420P	20	6.46	3.11	164	79	0.350 -0.860	9 - 22
520P	20	6.61	3.43	168	87	0.437 -1.187	11 - 30
330P	30	6.85	3.70	174	94	0.437 -1.187	11 - 30
430P	30	6.85	3.70	174	94	0.437 -1.187	11 - 30
530P	30	7.40	3.98	188	101	0.437 -1.450	11 - 37
360P	60	10.83	4.49	275	114	0.670 -1.625	17 - 41
460P	60	10.83	4.49	275	114	0.670 -1.625	17 - 41
560P	60	10.83	4.49	275	114	0.670 -1.625	17 - 41
3100P	100	12.3	5.00	312	127	0.950 -1.875	24 - 48
4100P	100	12.3	5.00	312	127	0.950 -1.875	24 - 48
5100P	100	12.3	5.00	312	127	0.950 -1.875	24 - 48

Connectors — North American Rated



20A, 30A Connector

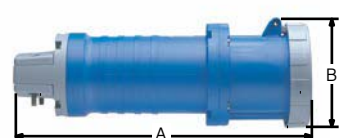

60A, 100A Connector

Dimensions for Connectors

Cat. No.	Amps	Unit (inches)		Unit (mm)		Cord Grip Range (Inches)	Cord Grip Range (mm)
		A	B	A	B		
320C	20	6.73	3.19	171	81	0.350 -0.860	9 - 22
420C	20	7.36	3.46	187	88	0.350 -0.860	9 - 22
520C	20	7.95	3.82	202	97	0.437 -1.187	11 - 30
330C	30	7.95	4.02	202	102	0.437 -1.187	11 - 30
430C	30	7.95	4.02	202	102	0.437 -1.187	11 - 30
530C	30	8.27	4.29	210	109	0.437 -1.450	11 - 37
360C	60	11.26	4.41	286	112	0.670 -1.625	17 - 41
460C	60	11.26	4.41	286	112	0.670 -1.625	17 - 41
560C	60	11.26	4.41	286	112	0.670 -1.625	17 - 41
3100C	100	12.8	4.84	325	123	0.950 -1.875	24 - 48
4100C	100	12.8	4.84	325	123	0.950 -1.875	24 - 48
5100C	100	12.8	4.84	325	123	0.950 -1.875	24 - 48

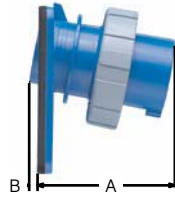
Inlets — North American Rated

20A, 30A Inlet

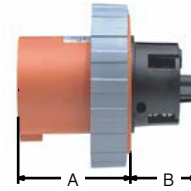

60A, 100A Inlet

Dimensions for Inlets

Cat. No.	Amps	Unit (inches)		Unit (mm)	
		A	B	A	B
320B	20	1.85	0.39	47	10
420B	20	2.09	0.39	53	10
520B	20	2.32	0.39	59	10
330B	30	2.36	0.47	60	12
430B	30	2.36	0.47	60	12
530B	30	2.64	0.47	67	12
360B	60	3.15	1.97	80	50
460B	60	3.15	1.97	80	50
560B	60	3.15	1.97	80	50
3100B	100	3.50	2.21	89	56
4100B	100	3.50	2.21	89	56
5100B	100	3.50	2.21	89	56

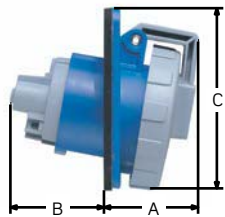
Receptacles — North American Rated

20A, 30A Receptacle

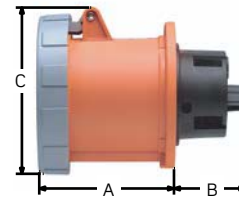

60A, 100A Receptacle

Dimensions for Receptacles

Cat. No.	Amps	Unit (inches)			Unit (mm)		
		A	B	C	A	B	C
320R	20	1.77	2.24	3.74	45	57	95
420R	20	1.77	2.24	3.74	45	57	95
520R	20	1.85	2.24	3.90	47	57	99
330R	30	2.20	2.40	4.10	56	61	104
430R	30	2.20	2.40	4.10	56	61	104
530R	30	2.20	2.44	4.37	56	62	111
360R	60	3.50	1.89	4.37	89	48	111
460R	60	3.50	1.89	4.37	89	48	111
560R	60	3.50	1.89	4.37	89	48	111
3100R	100	3.94	2.28	4.80	100	58	122
4100R	100	3.94	2.28	4.80	100	58	122
5100R	100	3.94	2.28	4.80	100	58	122

Inlets & Receptacles Drilling Plans — North American Rated

Drilling Plans for Inlets & Receptacles

Device Size	Device	A		B		C (min)		D
		inches	mm	inches	mm	inches	mm	
20A; 3-wire:	Receptacle	2.13	54	2.17	55	3.94	100	#8
	Inlet	1.93	49	1.73	44	3.35	85	#8
20A; 4-wire:	Receptacle	2.52	64	2.36	60	4.33	110	#8
	Inlet	2.32	59	2.05	52	3.94	100	#8
20A; 5-wire:	Receptacle	2.87	73	2.72	69	3.94	100	#8
	Inlet	2.32	59	2.05	52	3.94	100	#8
30A; 3-wire:	Receptacle	2.99	76	2.72	69	5.12	130	#8
	Inlet	2.56	65	2.40	61	4.53	115	#8
30A; 4-wire:	Receptacle	2.99	76	2.72	69	5.12	130	#8
	Inlet	2.56	65	2.40	61	4.53	115	#8
30A; 5-wire:	Receptacle	3.11	79	2.72	69	5.71	145	#8
	Inlet	2.56	65	2.40	61	4.53	115	#8
60A	All	2.76	70	2.40	61	6.69	170	#8
100A	All	3.19	81	2.80	71	7.87	200	#8

Drilling Plans

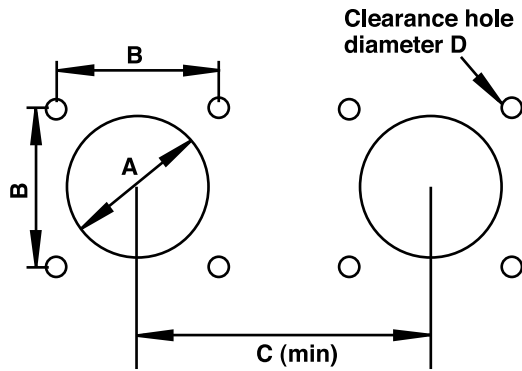

SPOTLIGHT

Industrial Devices

For over 107 years, Leviton has been helping businesses power their equipment safely, reliably, and efficiently. The Leviton line of rugged industrial electrical products comprises devices rated up to 1100A at 1000V, and includes devices with watertight and dust-tight ratings. For more information on Industrial devices visit us online at www.leviton.com/industrial



UL 1682 & 1686 Performance Specifications – North American Rated

Electrical		
Category	Specifications	
Dielectric Voltage	Devices rated $\leq 300V$: 2000V for 1 min. Devices rated $> 300V$: 3000V for 1 min.	
Insulation Resistance	500V for 1 min. insulation resistance ≥ 5 megohms	
Ground Path Current	Apply high current for short time and maintain continuity	
Overload	150% of rated current and 100% of rated voltage for 50 cycles (Power factor 0.75-0.80)	
Current Interrupting	Certified for current interrupting at full-rated current and voltage	
Temperature Rise	Max 30°C rise at full rated current (after overload)	
Resistance to Arcing	Continuation of overload for additional 200 cycles	
Endurance with Load	Device	# Cycles with Load
	20A	5000 Rated Current, Voltage
	30A, 60A	1000 Rated Current, Voltage
	100A	250 Rated Current, Voltage (Power Factor 0.75 - 0.80)

Mechanical		
Category	Specifications	
Mold Stress Relief	70°C for 7 hrs	
Humidity	32°C, 93% humidity, 168 hrs	
Cable Secureness	Pull force and apply torque for 1 minute	
Impact	Drop from 30" 8 times after conditioning to -25°C, for 6 hrs	
Crush	250 lbs for 1 min after -25°C for 6 hrs	
Withdrawal Force	Pull for one minute	
Strength of Insulating Base and Support	110% of specified tightening torque on terminal screws	
Polarization Integrity	Matching devices will not mate so that ground is energized even when polarization feature is removed and 40-lb insertion force applied	
Endurance with Load	Device	Total # Cycles (connect & disconnect)
	20A	5000
	30A, 60A	2000
	100A	500

Environmental		
Category	Specifications	
Flammability	V-2 or better on 20 and 30 Amp devices per UL 94 or CSA 22.2 #0.6 ; V-0 on 60 and 100 Amp devices	
Resistance to Corrosion	Ferrous parts immersed in 10% ammonium chloride solution at 20°C for 10 min.	
Moisture Resistance per UL 1682	Watertight: Device immersed for 24 hrs in 5 cm of 25°C water Splashproof: 1" dia. water stream at 15 PSI from 10 ft. for 5 minutes	
UV Resistance	Exposed plastic materials are UV stabilized	

Continued on next page



460P7W



460C12W

NORTH AMERICAN RATED | UL Performance Specifications

Continued from previous page

UL 1682 & 1686 Performance Specifications – North American Rated

Short-Time Grounding Test Currents

Device Rating Amps	Minimum Size Equipment Grounding Conductor (Copper)		Time Seconds	Test Current Amps
	AWG	(mm ²)		
20	12	(3.3)	4	470
30	10	(5.3)	4	750
60	10	(5.3)	4	750
100	8	(8.4)	4	1180

Ground-path integrity is of critical importance to safe operation of industrial equipment. Leviton pin and sleeve devices are tested by applying a test current through their ground path that far exceeds the device rating. All devices are properly wired and connected to line current at rated values. Then the ground path is subjected to a dramatic, sudden increase in current for 4 seconds. In all cases, the ground pin, sleeve and terminals of the devices must sustain the test current, continue to function properly, and show no evidence of damage or deterioration in any electrical or mechanical elements of the ground path. Test current values and test parameters are displayed in the above chart

Cord Secureness Test Values

Device Rating Amps	Force		Torque		Maximum Displacement	
	lb	N	ft-lb	N • M	inches	mm
20	30	133	0.4	0.54	≤3/32	2.38
30	75	333	0.5	0.68	≤3/32	2.38
60	150	667	1.0	1.4	≤3/32	2.38
100	150	667	2.0	2.7	≤3/32	2.38

Heavy cord stress is typical of industrial applications. To assure you of top performance, Leviton pin and sleeve devices are subjected to a punishing series of tests to confirm they can absorb heavy cord pulls. The cord conductors wired to devices are simultaneously twisted and pulled. Values for the applied twisting torque and force of pull are shown above. In all cases, the cord displacement is less than 3/32 inches

Minimum Withdrawal Force

Device Rating Amps	Minimum Withdrawal Force	
	lb	N
20	5	22
30	6	27
60	15	67
100	20	89

In industrial settings, inadvertent disconnection of power can be troublesome at best, dangerous at worst, and unacceptable in any case. To verify that Leviton pin and sleeve plugs and connectors remain securely connected, they are tested to establish the minimum force required for withdrawal. In establishing these minimum withdrawal forces, the plugs and connectors are properly mated, but not locked, with locking rings or other mechanical means. The pins and sleeves provide the only resistance to the force of withdrawal. In all cases, the values in the table above show the minimum force required to separate the plugs and connectors

SPOTLIGHT

30 Amp Stainless Steel Enclosed Safety Disconnect Switch

Our new 30 Amp, Non-Fused Safety Disconnect Switch features a Type 304, Non-Magnetic Stainless Steel enclosure for added resistance against bacterial growth and chemical corrosion. Ideal for use in areas requiring heavy washdown, the MDS30-AX is a perfect fit in food and beverage processing facilities, factories and plants, marinas and shipyards, and other abusive industrial applications. Visit www.leviton.com/powerswitch for more information on safety disconnect switches.



MECHANICAL INTERLOCKS | 60A and 100A

Continued from previous page

North American Watertight Mechanical Interlocks — Fused and Non-Fused

60A — Type 3R, 4X & 12K, IP67 & IP69K

Amp	Wiring	Voltage AC	Color	Receptacle Config.	Plug Config.	Cat. No. Non-Fused Mech. Interlock	HP Rating	Cat. No. Fused Mech. Interlock	HP Rating	Cat. No. Use Plug
60	2p3w	240	Blue			360MI6W	10	360MF6W	*	360P6W
	2p3w	480	Red			360MI7W	20	—	—	360P7W
	3p4w	125/250	Orange			460MI12W	*	460MF12W	*	460P12W
	3p4w	3Ø240	Blue			460MI9W	20	460MF9W	15	460P9W
	3p4w	3Ø480	Red			460MI7W	40	460MF7W	30	460P7W
	3p4w	3Ø600	Black			460MI5W	40	460MF5W	50	460P5W
	4p5w	3ØY120/208	Blue			560MI9W	20	560MF9W	15	560P9W
	4p5w	3ØY277/480	Red			560MI7W	40	—	—	560P7W
	4p5w	3ØY347/600	Black			560MI5W	40	—	—	560P5W

*Consult factory for your specific application.
Fused models accept "Class J" Time-delay fuses

North American Watertight Mechanical Interlocks — Non-Fused and Breakered

100A — Type 3R, 4X & 12K, IP67 & IP69K

Amp	Wiring	Voltage AC	Color	Receptacle Config.	Plug Config.	Cat. No. Non-Fused Mech. Interlock	HP Rating	Cat. No. Breakered Mech. Interlock	HP Rating	Cat. No. Use Plug
100	2p3w	125	Yellow			3100MI4W	*	—	—	3100P4W
	2p3w	240	Blue			3100MI6W	15	—	—	3100P6W
	2p3w	480	Red			3100MI7W	25	—	—	3100P7W
	3p4w	125/250	Orange			4100MI12W	*	—	—	4100P12W
	3p4w	3Ø240	Blue			4100MI9W	30	4100MB9W	30	4100P9W
	3p4w	3Ø480	Red			4100MI7W	50	4100MB7W	50	4100P7W
	3p4w	3Ø600	Black			4100MI5W	50	—	—	4100P5W
	4p5w	3ØY120/208	Blue			5100MI9W	25	5100MB9W	25	5100P9W
	4p5w	3ØY277/480	Red			5100MI7W	50	—	—	5100P7W
	4p5w	3ØY347/600	Black			5100MI5W	50	—	—	5100P5W

*Consult factory for your specific application

