



Energy Control Solutions for Hospitality Settings

Smart Climate and Lighting Control Ensures Comfort and Efficiency

Code Compliant Hospitality Guest Room Control

ENHANCE GUEST COMFORT AND BOOST ENERGY SAVINGS

Whether in the construction phase of a new structure or retrofitting an existing building, smart HVAC and lighting control technologies can drastically reduce energy consumption. The Omnistat3 Hospitality Thermostat is specifically designed to meet the needs and code compliance requirements of the hospitality industry. The Omnistat3 maintains the guest room in an energy-saving Unoccupied versus Occupied state when activated by a hardwired key card switch that tracks the entrance and exit of occupants. Combined with LevNet RF™ wireless products, this solution meets code requirements and enhances the guest experience with ambient lighting, dimming and optimal HVAC control. Solutions are easy to install with free software for easy deployment of multi-room properties and no new wires to pull, ensuring unparalleled flexibility.

Leviton hospitality solutions offer reliable, cost-effective control of lighting and HVAC systems, and create networkable, scalable alternatives to traditional hotel room controls. Upgrade guest rooms to smarter, more reliable controls to enhance guest experiences, improve the working environment for staff and meet energy code requirements, including California Title 24 2013 and ASHRAE Standard

PROBLEM

Hotel managers are retrofitting guest rooms to save energy while allowing guests to seamlessly enjoy the comfort features of the room.

- Facility is a pre-existing structure that was not designed with energy conservation considerations
- When returning to their rooms, guests expect adequate lighting immediately upon entry and optimal climate control
- Facility must remain open and operational during retrofit process with minimal disruptions
- No new wires can be pulled

SOLUTION

Easily add hardwired and wireless control for switching or dimming lighting, and heating and cooling for guest comfort.

- Activated by a key card switch (or wireless window/door sensor) that activates occupancy-level lighting and HVAC systems upon entry; when guests leave, the key card switch or sensor will prompt all connected devices to enter an Energy Saving Mode
- Manual in-room controls allow guests and staff to control lighting and air flow to ensure the best guest experience
- Quick and easy to retrofit into new and existing structures, requiring minimal labor and causing no significant disturbances to facility operations

HARDWIRED VS. WIRELESS COSTS

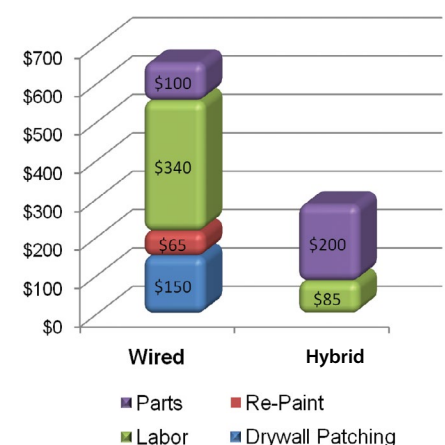

*Installation time per device: 45-50 minutes for hardwire vs. 10-15 minutes for wireless devices.

Leviton Manufacturing Co., Inc. Global Headquarters

201 N. Service Rd. Melville, NY 11747-3138 • Tech Line: 1-800-824-3005 • Fax: 1-800-832-9538

© 2015 Leviton Manufacturing Co., Inc. All rights reserved. Subject to change without notice.

TITLE 24 GUEST ROOM SOLUTION—DIMMING

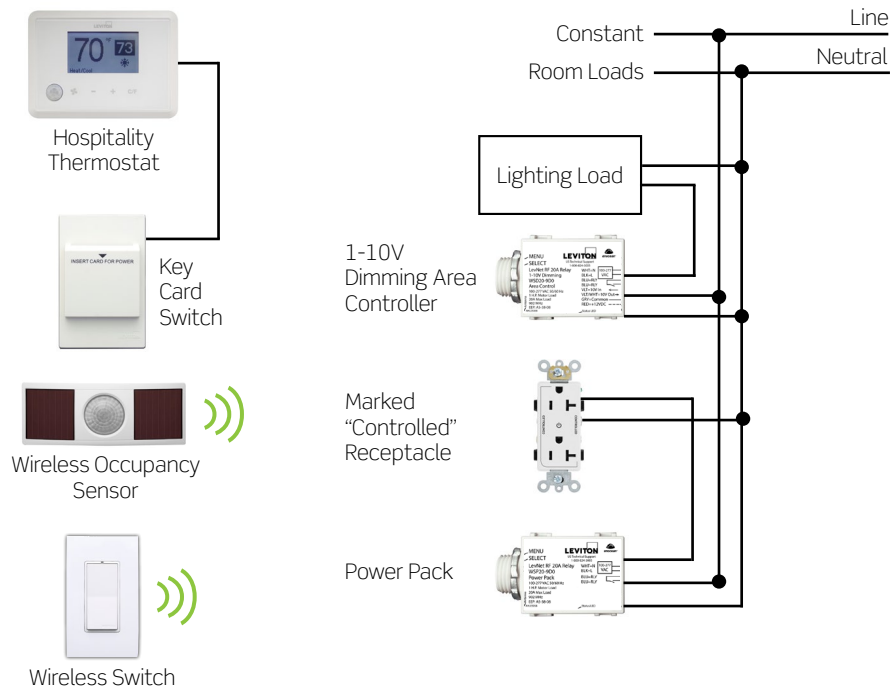







NOTE: Solutions shown meet the requirements of California Title 24 2013 Section 130.1(c) Automatic Shut-Off Controls for hotel guest rooms and 120.2 Hotel/Motel Guest Room and High-Rise Residential Dwelling Unit Thermostats.

For additional information, visit www.leviton.com/title24

Disclaimer: This document is for informational purposes only. Each project will have its own specific requirements for satisfying California Title 24 2013 code compliance based on a variety of factors. Other exceptions or details may apply. Review the code for specific requirements and/or consult with a professional advisor. Leviton Mfg. Co., Inc. is not responsible for any loss resulting from the use of any information found in this document. Solutions are subject to change without notice. For additional assistance, contact your local Leviton representative.

Components for a Title 24 Guest Room Solution with Dimming

List of Equipment	
	Omnistat3 Hospitality Thermostat RC500-2EW
	Hardwired Hospitality Key Card Switch HKSWP-0Lx*
	LevNet RF Wireless Sensor WSC12-M9N
	LevNet RF Decora Wall Switch Receiver WSS05-S9W
	LevNet RF 1-10V Dimming Area Controller WSD20-9D0
	LevNet RF Power Pack WSP20-9D0
	Marked "Controlled" Receptacle 16352-2Px

* HKSWP ships with a Color Change Kit - includes a White, Ivory and Light Almond faceplate.

Leviton Manufacturing Co., Inc. Global Headquarters

201 N. Service Rd. Melville, NY 11747-3138 • Tech Line: 1-800-824-3005 • Fax: 1-800-832-9538

Visit our Website at: www.leviton.com/guestroomcontrol

© 2015 Leviton Manufacturing Co., Inc. All rights reserved. Subject to change without notice.