

SCEPTER RIGID PVC CONDUIT & FITTINGS

1/2" - 6" (12mm - 150mm)



Professional electricians ask for Scepter conduit by name for the quality and superior performance that ensures a long trouble free life. Scepter conduit is light weight and offers excellent chemical resistance, high tensile and impact strength, and the FT-4 rating permits use in noncombustible construction.

Suitable for exposed, concrete encased and direct burial applications, Scepter conduit requires no extra protection and is third party certified by CSA, UL and NRTL.

SHORT FORM SPECIFICATIONS

All wiring shall be installed in Rigid PVC conduit and secured to PVC boxes and cabinets by means of proper fittings. All boxes, access fittings and covers shall be furnished with threaded brass inserts, brass screws and PVC gaskets.

Rigid PVC fittings and junction boxes shall be used for all outlets, pull boxes and junction points. All PVC junction boxes shall be NEMA 1, 2, 3, 4, 4X, 6P, 12 and 13 rated and UL Listed for wet locations.

Exposed conduit shall be securely held in place by suitable hangers or straps with the maximum spacing of points for supports not exceeding those specified in the CEC or NEC. Except when embedded in concrete, rigid conduit pipe shall not be clamped tightly. It shall be supported in such a manner as to permit adequate linear movement, allowing for expansion and contraction of conduit due to temperature change. Where a temperature change exceeding 25°F (14°C) is anticipated, rigid PVC expansion joints shall be installed in accordance with the manufacturer's recommendations.

Proper care shall be taken when field bending, to maintain the internal diameter and wall thickness of the conduit.

The contractor shall furnish and install Scepter Rigid PVC conduit pipe and fittings made by IPEX. Where the engineer's specifications indicate Scepter products or equivalent, the equivalent shall be CSA certified and accepted by the Canadian Electrical Code. Due to broad manufacturing tolerances, all pipe and fitting products shall be of the same manufacturer.

APPLICATIONS

- Utilities
- Cable
- Communications
- Residential
- Airports
- Subways
- Bridges & tunnels
- Water treatment plants
- Sewage treatment plants
- Pulp & paper industries
- Street & highway lighting
- Food processing plants
- Agricultural, dairy, hogs, cattle, chicken, etc.
- Parking garages
- Car washes
- Fish plants
- Mines
- Marinas
- Steel mills

STANDARDS



Scepter Rigid PVC Conduit conforms to: CSA C22.2 No. 211.2, CSA C22.2 No. 211.0
NSF Certified to UL651
Sunlight Resistant
Rated for use with 90°C conductors
NEMA TC2
Corps. of Engineers Spec. CE 303:01
Military Spec, Federal Spec. WC 1094A

Scepter Rigid PVC boxes and fittings conform to: CSA C22.2 No. 85

UL Listed UL514B - UL514C

DID YOU KNOW?

Compared to metal, PVC products reduce labour on a typical installation by up to two-thirds. The reason? PVC is easy to work with. It can also be cut and joined without the usual pipe vices, cutters, threading equipment, and reamers associated with metal conduit.

ADVANTAGES

- 1 Sunlight resistant**
Electrical nonmetallic Scepter Rigid PVC conduit meets the 2009 electrical code criteria for sunlight resistance, is approved for the purpose, and is appropriately marked.
- 2 Lightweight Conduit**
Scepter Rigid PVC Conduit is one-half the weight of aluminum and one-sixth the weight of steel. As a result, handling and installation are easier and faster, reducing labour costs.
- 3 Easy Joining**
Solvent cementing is all that is required, eliminating the need for power-threading machines, pipe vices and cutting equipment. A hacksaw or carpenter's saw is the only equipment required.
- 4 Strength**
Scepter Rigid PVC Conduit offers both high impact and high tensile strength. And, even in cold temperatures, exceeds all CSA and UL standards.
- 5 Easy Wire Pulls**
PVC's exceptionally smooth interior surface greatly reduces the amount of friction while pulling conductors/ wires through long runs, even with 90° bends. A large pull-rope and wire-pulling lubricant should be used when pulling all conductors and wires.
- 6 Noncorroding**
PVC is immune to damage from naturally corrosive soil conditions, as well as electro-chemical and galvanic corrosion. This ensures lower maintenance costs and superior performance.
- 7 Nonconducting**
Scepter Rigid PVC Conduit pipe and fittings are nonsparking and nonconducting, thereby eliminating the most dangerous 'second point of contact' and 'phase to ground' faults. The use of a separate grounding conductor in a Scepter PVC conduit system gives a complete and positive ground for the whole system.
- 8 Chemical resistance**
One of the greatest benefits of PVC is its excellent chemical resistance. It resists attack by acids, alkalis, salt solutions, and many other types of chemicals. For more information on PVC and chemical resistance, refer to the IPEX Chemical Resistance Guide.
- 9 Long Life**
Scepter Rigid PVC Conduit pipe and fittings retain their original properties after years of exposure to heat and weather. In addition, resistance to fungi, bacterial action, rodents, termites and corrosive agents ensures a long, trouble-free life for PVC conduit installed indoors or outdoors.
- 10 Fire Resistant**
IPEX's proprietary PVC compound used to manufacture Scepter products is a self-extinguishing material and will not support combustion.

| IPEX Compound | Flame Spread | Smoke Developed | Fuel Contribution |
|----------------|--------------|-----------------|-------------------|
| 1/8" thickness | 10 - 20 | 225 - 270 | 0 |
| 3/4" thickness | 10 - 20 | 300 - 390 | 0 |

- 11 Concrete Tight**
Scepter Rigid PVC Conduit pipe and fittings are designed and engineered to be concrete tight in all weather conditions.

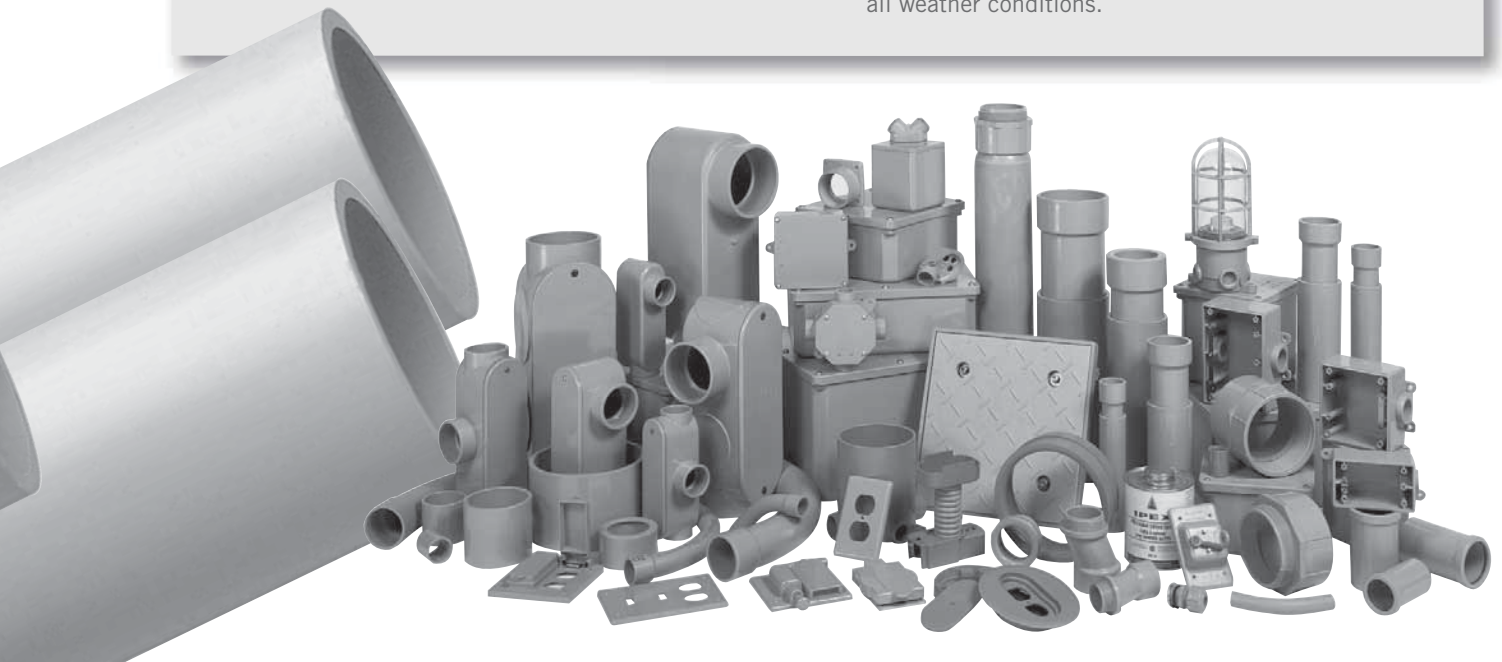

TECHNICAL INFORMATION

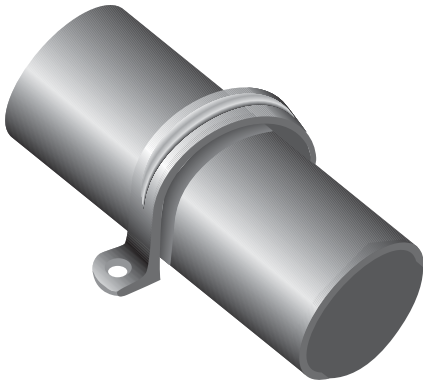

SUPPORT

Due to PVC's light weight, support spacing is different than that used with metal conduits. Supporting straps should NOT be firmly tightened, so that linear movement of the pipe is possible. The maximum allowable support spacing, per the Canadian Electrical Code (CEC) is as follows:

SUPPORT SPACING

| Nominal Conduit Diameter | | Canadian Electrical Code Max. Support Spacing | |
|--------------------------|-----|---|--------|
| inches | mm | feet | metres |
| 1/2 | 12 | 2-1/2 | .75 |
| 3/4 | 20 | 2-1/2 | .75 |
| 1 | 25 | 2-1/2 | .75 |
| 1-1/4 | 32 | 4 | 1.20 |
| 1-1/2 | 40 | 4 | 1.20 |
| 2 | 50 | 5 | 1.50 |
| 2-1/2 | 65 | 6 | 1.80 |
| 3 | 75 | 6 | 1.80 |
| 3-1/2 | 90 | 7 | 2.10 |
| 4 | 100 | 7 | 2.10 |
| 5 | 125 | 7 | 2.10 |
| 6 | 150 | 8 | 2.50 |



MAX OPERATING TEMPERATURE

The Canadian Electrical Code (CEC) allows the use of Scepter Rigid PVC Conduit up to a maximum ambient temperature of 167°F (75°C).

CUTTING

Scepter Rigid PVC Conduit can be easily cut on the jobsite by using a hacksaw, carpenter's saw or PVC conduit cutters. For larger sizes of conduit, the use of a mitre box is also recommended to ensure a square cut.

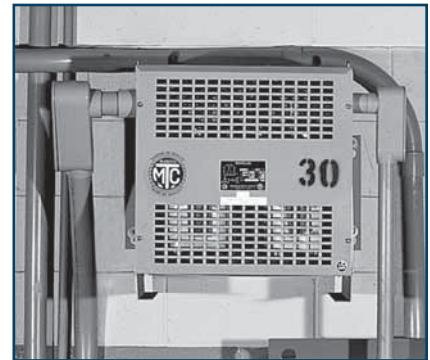

TECHNICAL INFORMATION

SOLVENT CEMENTING

After cutting Scepter Rigid PVC Conduit, remove all sharp edges or burrs from the inside of the conduit with a knife. Thoroughly clean the end of the pipe and inside the fitting with a rag or pipe cleaner. Check the pipe and fitting for a dry fit before cementing. Apply a generous amount of IPEX solvent cement to both surfaces; slide together and give a quarter turn to ensure the solvent is spread evenly on the material. Hold together for a few seconds until the joint is made.

Usually the solvent-cemented joint will be strong enough to install immediately. However, in climates with low temperatures or areas with high humidity, extra time may be required before moving the pipe for permanent installation. Solvent-cemented joints appear to “set up” instantly, but will take up to 24 hours to cure properly. After this time, the solvent-cemented joint has completely cured and is waterproof. For extreme cold weather installations, the use of IPEX PVC Primer is recommended. Normal installation temperatures are between 40°F (4°C) and 110°F (43°C), however, high strength joints have been made at temperatures as low as -15°F (-26°C) with quality cements. In these extreme conditions the cement must be kept warm to prevent excessive thickening and gelation in cold weather.

IPEX cements and primers are available in quarter-pint (125ml), half-pint (250ml), pint (500ml), quart (1-litre) and gallon (4-litre) containers. The shelf life of conduit cement and primer is 2 years from the date of manufacture. The date code stamped on the bottom of the can is the date of manufacture, not the expiry date. Always verify that the cement is within this 2 year time frame before using.



BENDING

PVC is a thermoplastic material that, when heated, becomes soft and pliable. As a result, its shape can be altered.

A flameless heat source is recommended to heat the pipe. AN OPEN FLAME SHOULD NOT BE USED. An electric unit or an infra-red propane unit is recommended for heating the pipe.

The necessary temperature for bending Scepter Rigid PVC pipe is 260°F (127°C). The pipe must be heated evenly over an area approximately ten times the diameter of the pipe before any attempt at bending is made. Bending the pipe when it has not been thoroughly heated will cause the pipe to “kink.” With proper care and a little practice, the bend will form easily.

Cooling the pipe with cold air or water will cause “spring back.” Allow a few extra degrees of overbending to compensate for this phenomenon. The maximum bending radius shall be six times the internal diameter according to the Canadian Electrical Code and the National Electrical Code.



TECHNICAL INFORMATION EXPANSION FITTINGS

USING EXPANSION JOINTS

It is equally important to know when to install an expansion joint as it is to know how to correctly install the expansion joint. Expansion joints are required when the temperature change is greater than 25°F (14°C). Scepter Rigid PVC Conduit has a coefficient of linear expansion of 3.6×10^{-4} in./ft./°F (.054mm/m/°C). Generally, a 100 ft. (30.48m) run of PVC conduit will undergo a change in length of 3.6 inches (91.44mm) for every 100°F (56°C) temperature change.

For conduit installed indoors, the range of expansion and contraction can be calculated using the maximum air temperature plus the heat contributed by the conductors inside the conduit and the minimum air temperature expected. Expansion joints are not required indoors unless there are widely varying temperatures such as the attic of a building.

Conduit installed outdoors, exposed to direct sunlight, will be considerably hotter than the air temperature. As a guideline in this case, add 27°F (15°C) to the temperature change. Expansion joints should be installed to allow for all anticipated temperature changes.

EXPANSION FORMULA

By using the following formulas and the charts below, the total expected expansion in a run can be easily determined:

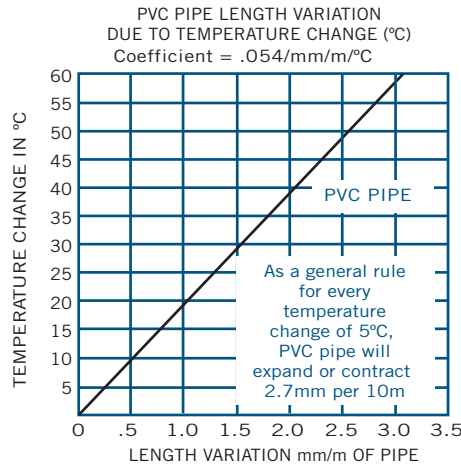
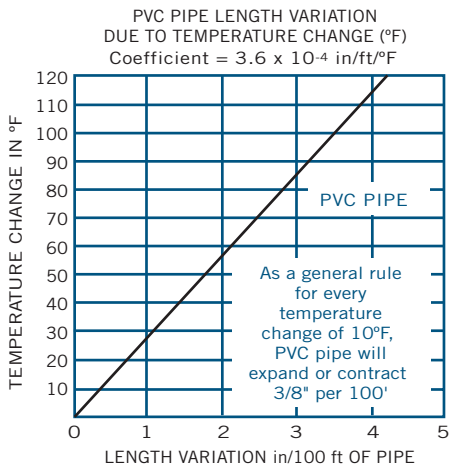

°F Total Expansion (in.) = length of run (ft.)
x temperature change (°F) x 0.00036

or

°C Total Expansion (mm) = length of run (m)
x temperature change (°C) x 0.054

TECHNICAL INFORMATION EXPANSION FITTINGS

NUMBER OF EXPANSION JOINTS REQUIRED

Use the following equation to determine the number of expansion joints needed for a Scepter Rigid PVC Conduit installation:

$$\text{Number of joints} = \frac{\text{total expansion (mm or in)}}{E}$$

E = Expansion joint travel length 101.6mm (4") or 203.2mm (8") depending on diameter.

Always round up to the next whole number.

SETTING THE PISTON OPENING

The expansion joint must be installed to allow for expansion and contraction of the conduit run. On a cold day, if an expansion joint is installed completely closed with the piston bottomed, there is no room for expansion when the conduit is warmed. If it is installed open to the maximum on a hot day, the expansion joint will pull apart when cooled.

The correct piston opening for any installation condition can be easily determined using the formula below.

$$\text{Piston setting} = \text{compressed length} + \left(\frac{\text{max. temperature} - \text{installation temperature}}{\text{max. temperature} - \text{min. temperature}} \right) \times E$$

Formula can be used for both metric and imperial measurements.

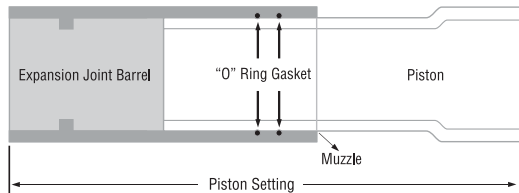

| Size | | Compressed Length | | Travel | |
|------|-------|-------------------|-------|--------|------|
| (mm) | (in) | (mm) | (in) | (mm) | (in) |
| 13 | 1/2 | 203.2 | 8.00 | 101.6 | 4 |
| 20 | 3/4 | 203.2 | 8.00 | 101.6 | 4 |
| 25 | 1 | 215.9 | 8.50 | 101.6 | 4 |
| 32 | 1-1/4 | 228.6 | 9.00 | 101.6 | 4 |
| 38 | 1-1/2 | 228.6 | 9.00 | 101.6 | 4 |
| 51 | 2 | 235.0 | 9.25 | 101.6 | 4 |
| 64 | 2-1/2 | 235.0 | 9.25 | 101.6 | 4 |
| 76 | 3 | 362.0 | 14.25 | 203.2 | 8 |
| 89 | 3-1/2 | 362.0 | 14.25 | 203.2 | 8 |
| 102 | 4 | 362.0 | 14.25 | 203.2 | 8 |
| 127 | 5 | 362.0 | 14.25 | 203.2 | 8 |
| 152 | 6 | 362.0 | 14.25 | 203.2 | 8 |

COMMON MISTAKES

Three common mistakes are:

1. Forgetting to use expansion joints.
2. Not using enough expansion joints.
3. Overtightening of support straps.

It is more cost effective to use more expansion joints than needed, rather than too few. It is difficult to correct the problem after conductors are installed and in service. Failure to accommodate expansion/contraction may result in pipe fracture.

TECHNICAL INFORMATION EXPANSION FITTINGS

INSTALLATION OF EXPANSION JOINTS

USING EXPANSION JOINTS

Proper functioning of an expansion joint depends on three procedures:

1. The correct placement of the expansion joint.
2. The proper installation of Scepter Rigid PVC Conduit and the expansion joint.
3. The proper placement and fastening of support straps.

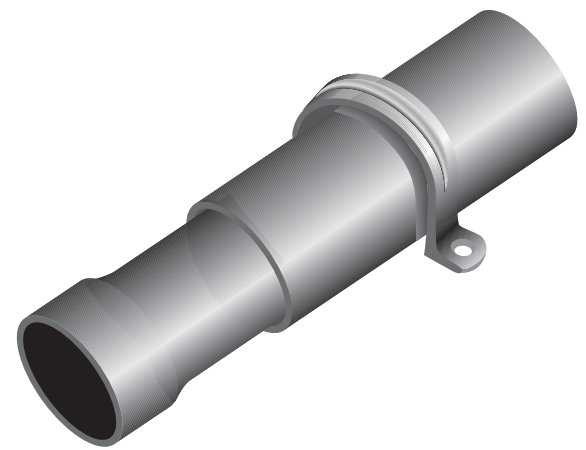

One Expansion Joint - Figure 1

If only one expansion joint is needed between two boxes, the barrel of the joint should be rigidly fastened close to the first box. Scepter Rigid PVC Conduit should then be loosely supported with straps, allowing the conduit to move freely as it expands and contracts.

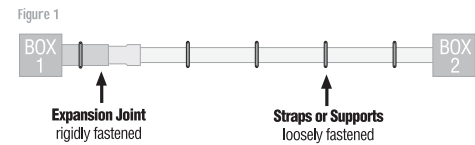

Two Expansion Joints - Figure 2

If two expansion joints are needed, the joints should be firmly fastened back to back at the centre of the run. Scepter Rigid PVC Conduit should be loosely supported with straps, allowing the conduit to move freely as it expands and contracts.

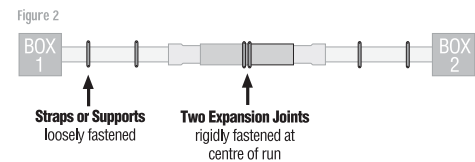

Two Expansion Joints (Alternative) - Figure 3

Alternatively, the centre of the run and the two expansion joints (located at the boxes) should be rigidly fastened. All other support straps should be loosely fastened.

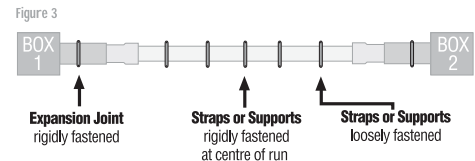

Three or More Expansion Joints - Figure 4

If more than two joints are needed in a very long run, they should be put in a series, one after the other. Each barrel must be rigidly fastened while conduit is loosely supported with straps allowing the conduit to move freely as it expands and contracts. When installed in a series, each section acts independently of the other. Spacing of conduit supports must be in accordance with Section 12-1114 of the Canadian Electrical Code or NEC Article 347-8. (See Table on Support Spacing)

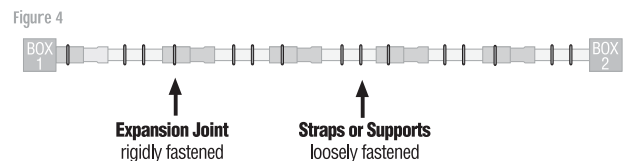

INSTALLATION RECOMMENDATIONS

- Expansion joints should be mounted so the piston can travel in a straight line in the barrel. If the alignment is not straight, the piston will bind, preventing the joint from functioning correctly.
- The expansion joint barrel should be clamped tight, but the conduit mounted loose enough in its hangers to allow for movement as it expands and contracts.
- Scepter nonmetallic straps are correctly sized and designed for proper support, and must be used to secure the conduit.
- When expansion joints are used in a vertical position, the piston should be mounted in a downward position so dirt cannot deposit between the barrel and piston at the muzzle of the expansion joints.

CONDUIT ELBOWS

| Size inches | Part Number | Product Code | D inches | T inches | R inches |
|-------------|-------------|--------------|----------|----------|----------|
|-------------|-------------|--------------|----------|----------|----------|

90° Elbows c/w Solvent Bell End (Bell End x Plain End)

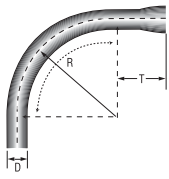

*plain end x plain end only

| | | | | | |
|--------|--------|--------|-------|-------|-------|
| 1/2 | EE1090 | 069081 | 0.840 | 1.500 | 4.00 |
| 3/4 | EE1590 | 069082 | 1.050 | 1.500 | 4.50 |
| 1 | EE2090 | 069083 | 1.315 | 1.875 | 5.75 |
| 1-1/4 | EE2590 | 069084 | 1.660 | 2.000 | 7.25 |
| 1-1/2 | EE3090 | 069085 | 1.900 | 2.000 | 8.25 |
| 2 | EE3590 | 069086 | 2.375 | 2.000 | 9.50 |
| 2-1/2 | EE4090 | 069087 | 2.875 | 3.000 | 10.50 |
| 3 | EE4590 | 069088 | 3.500 | 3.125 | 13.00 |
| 3-1/2* | EE5090 | 069089 | 4.000 | 3.250 | 15.00 |
| 4 | EE5590 | 069090 | 4.500 | 3.375 | 16.00 |
| 5 | EE6090 | 069091 | 5.563 | 3.625 | 24.00 |
| 6 | EE6590 | 069092 | 6.625 | 3.750 | 30.00 |
| 8* | EE7090 | 069099 | 8.622 | 8.300 | 48.00 |

45° Elbows c/w Solvent Bell End (Bell End x Plain End)

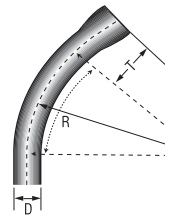

*plain end x plain end only

| | | | | | |
|--------|--------|--------|-------|-------|-------|
| 1/2 | EE1045 | 069201 | 0.840 | 1.500 | 4.00 |
| 3/4 | EE1545 | 069202 | 1.050 | 1.500 | 4.50 |
| 1 | EE2045 | 069203 | 1.315 | 1.875 | 5.75 |
| 1-1/4 | EE2545 | 069204 | 1.660 | 2.000 | 7.25 |
| 1-1/2 | EE3045 | 069205 | 1.900 | 2.000 | 8.25 |
| 2 | EE3545 | 069206 | 2.375 | 2.000 | 9.50 |
| 2-1/2 | EE4045 | 069207 | 2.875 | 3.000 | 10.50 |
| 3 | EE4545 | 069208 | 3.500 | 3.125 | 13.00 |
| 3-1/2* | EE5045 | 069209 | 4.000 | 3.250 | 15.00 |
| 4 | EE5545 | 069210 | 4.500 | 3.375 | 16.00 |
| 5 | EE6045 | 069211 | 5.563 | 3.625 | 24.00 |
| 6 | EE6545 | 069212 | 6.625 | 3.750 | 30.00 |
| 8* | EE7045 | 069213 | 8.622 | 8.300 | 48.00 |

30° Elbows Plain End x Plain End

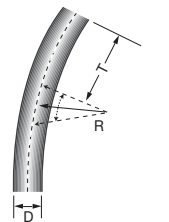

| | | | | | |
|-------|--------|--------|-------|-------|-------|
| 1/2 | EE1030 | 069241 | 0.840 | 1.500 | 4.00 |
| 3/4 | EE1530 | 069242 | 1.050 | 1.500 | 4.50 |
| 1 | EE2030 | 069243 | 1.315 | 1.875 | 5.75 |
| 1-1/4 | EE2530 | 069244 | 1.660 | 2.000 | 7.25 |
| 1-1/2 | EE3030 | 069245 | 1.900 | 2.000 | 8.25 |
| 2 | EE3530 | 069246 | 2.375 | 2.000 | 9.50 |
| 2-1/2 | EE4030 | 069247 | 2.750 | 3.000 | 10.50 |
| 3 | EE4530 | 069248 | 3.500 | 3.125 | 13.00 |
| 3-1/2 | EE5030 | 069249 | 4.000 | 3.250 | 15.00 |
| 4 | EE5530 | 069250 | 4.500 | 3.375 | 16.00 |
| 5 | EE6030 | 069251 | 5.563 | 3.625 | 24.00 |
| 6 | EE6530 | 069252 | 6.625 | 3.750 | 30.00 |
| 8 | EE7030 | 069254 | 8.622 | 8.300 | 48.00 |

Utility 90° Elbows c/w Solvent Bell End (Bell End x Plain End)

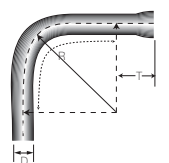

| | | | | | |
|---|----------|--------|-------|--------|-------|
| 2 | NSL 2-24 | 069257 | 2.375 | 41.200 | 24.00 |
| 2 | NSL 2-36 | 069260 | 2.375 | 31.700 | 36.00 |
| 3 | NSL 3-24 | 069265 | 3.500 | 41.200 | 24.00 |
| 3 | NSL 3-36 | 069261 | 3.500 | 31.700 | 36.00 |
| 4 | NSL 4-36 | 069267 | 4.500 | 31.700 | 36.00 |
| 4 | NSL 4-48 | 069266 | 4.500 | 31.700 | 48.00 |
| 5 | NSL 5-36 | 069263 | 5.563 | 31.700 | 36.00 |
| 6 | NSL 6-36 | 069264 | 6.625 | 31.700 | 36.00 |

CSA Utility 90° Elbows are made from 10 ft. pipe.