

Whether you're looking for economical outdoor lighting solutions or corrosion-resistant fixtures for punishing industrial environments, Sceptalight fixtures from IPEX prove themselves to be all-round performers in a variety of indoor and outdoor applications. Sceptalight fixtures are made from a glass-reinforced thermoplastic polyester resin, which enable them to stand up better to corrosive elements than metal. This thermoplastic design marries an unrivaled balance of strength, stiffness and toughness with all the benefits users appreciate of Scepter rigid PVC conduit and fittings – long life, easy servicing and high impact-resistance.

Sceptalight's thermoplastic construction offers outstanding corrosion and chemical resistance. And its interior and exterior silicone gaskets create a watertight seal, the reason it performs equally well indoors and outside.

Wherever you need a lighting fixture that can withstand exposure to chemicals, fluids or harsh physical conditions, you'll find a home for Sceptalight.

# Nonmetallic Light Fixtures

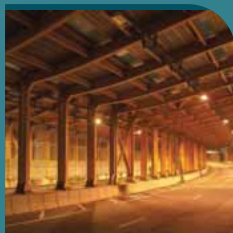

Sceptalight Nonmetallic Light Fixtures

# SCEPTALIGHT NONMETALLIC LIGHT FIXTURES



Whether you're looking for economical outdoor lighting solutions, corrosion-resistant fixtures for punishing industrial environments or energy-saving LED, Sceptalight fixtures from IPEX prove themselves to be all-round performers in a variety of indoor and outdoor applications. Sceptalight fixtures are made from a glass-reinforced thermoplastic polyester resin, which enable them to stand up better to corrosive elements than metal. This thermoplastic design marries an unrivaled balance of strength, stiffness and toughness with all the benefits users appreciate of Scepter rigid PVC conduit and fittings – long life, easy servicing and high impact-resistance.

Sceptalight's thermoplastic construction offers outstanding corrosion and chemical resistance. Silicone gaskets in Sceptalight fixtures – mounted at the base of the globe and within the ceiling box – provide a water- and vapor-tight seal which protects the electrical connections inside.

Wherever you need a lighting fixture that can withstand exposure to chemicals, fluids or harsh physical conditions, you'll find a home for Sceptalight.

## APPLICATIONS

- Chemical Plant
- Marine
- Food Processing
- Agricultural
- Highway Tunnel
- Waste Water
- Mine Tunnels
- Greenhouses
- Walk-in Freezers
- Industrial/Commercial

## STANDARDS



### WET LOCATIONS

C22.2 No. 250  
CSA Listed to UL 1598  
Minimum 60°C supply conductors

CSA certified for wet locations, Sceptalight fixtures are built to withstand any environment where liquids drip, splash or flow against electrical equipment. And our polycarbonate globes are an excellent alternative to glass in punishing environments where high impact resistance is important. Sceptalight fixtures can operate in extreme temperatures and are resistant to damaging ultraviolet rays. For years, our fixtures have been proven performers on docks, wharfs, decks, walkways, shipyards and a variety of other applications where exposed to the elements.

LIGHT OPTIONS	
LED	✓
Incandescent	✓
Compact Fluorescent	✓

### MARINE LOCATIONS

CSA C22.2 No. 250  
UL 1598, UL 1598A  
Minimum 100°C supply conductors

Sceptalight offers fixtures that meet marine location certification, UL 1598A, a supplemental approval to the wet location standard. Marine approved luminaires are rated to be used in salt water environments including conditions such as salt spray corrosion, ignition protection, UV exposure and water ingress making them the ideal choice for shipping vessels and outside marine applications. Sceptalight marine rated fixtures come with a standard clear glass globe and require a 100W incandescent bulb.

LIGHT OPTIONS	
LED	
Incandescent	✓
Compact Fluorescent	

### HAZARDOUS LOCATIONS

CSA Listed to UL 844  
CLASS I, DIV 2 Groups A, B, C & D  
CLASS II, DIV 2 Groups F & G  
Minimum 90°C supply conductors

Sceptalight offers fixtures that are CSA certified for hazardous locations, making them the ideal choice for specific harsh industrial environments involving flammable or explosive gases, vapours or dusts. In addition to their sturdy construction, all our fixtures rated for hazardous locations include a heat-treated globe designed to endure drastic temperature changes such as direct spray of cool water on a hot fixture. Sceptalight fixtures are equipped with brass screws and inserts to ensure performance in punishing industrial conditions.

LIGHT OPTIONS	
LED	
Incandescent	✓
Compact Fluorescent	✓

# SCEPTALIGHT LED

Introducing three new Sceptalight LED products: the LED Retrofit Light Engine, the Heavy-Duty LED Light Fixture and the Utility LED Light Fixture. Sceptalight LEDs offer significant energy savings, up to 85% compared to incandescent, and up to 34% compared to fluorescents. Moreover, Sceptalight LEDs can last beyond 50,000 hours without a single need for maintenance.

Constructed of very strong and durable materials, the polycarbonate globe is impact resistant and is resistant to UV light degradation. The specially designed aluminum heat sink dissipates the heat generated by the LEDs to the exterior environment ensuring long-life and optimal performance in both hot and cold environments. Sceptalight LEDs have been tested and certified for use in indoor, outdoor, wet location, wash down and corrosive environments. They are certified to the latest LED light fixture standards and NEMA 4X approved.

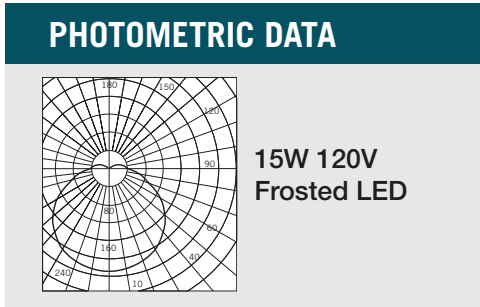

**STANDARDS**

LIGHT FIXTURE (LVPF/LVPE-LED)	CSA C22.2 250.0	UL 1598
LIGHT ENGINE (LLED-15)	CSA T.I.L. B-79A	UL 1598C



### RETROFIT OPTION

Sceptalight LEDs can easily retrofit onto existing installations for increased energy savings.

### CORROSION RESISTANT

Heat sink is coated with a durable e-coat layer that prevents corrosion.

### NEMA 4X AND IP66 RATED

Approved for wet locations, wash down and corrosive environments.

### HEAT DISSIPATION

Specially designed heat sink ensures long life and optimum performance for over 50,000 hours.

### ENERGY EFFICIENT

1,000 lumens of light output is produced with only 15 Watts of electricity.

### DIMMABLE

Lights are dimmable down to 5% for maximum control of the lighting environment.

### POLYCARBONATE GLOBE

Impact and weather resistant for tough environments.

## TECHNICAL SPECIFICATIONS

LUMEN OUTPUT .....	1000 LM	POWER FACTOR .....	0.98
INPUT VOLTAGE .....	120 VAC	TOTAL HARMONIC DISTORTION .....	10.5%
FREQUENCY .....	60 HZ	OPERATING TEMPERATURE .....	-40 C TO 40 C
NOMINAL POWER .....	15 W	DIMMABILITY RANGE .....	DOWN TO 5%
COLOUR TEMPERATURE .....	5000 K	RATED LIFE .....	> 50,000 HOURS
CRI .....	> 80	WARRANTY* .....	5 YEARS

\*LIMITED WARRANTY & LIMITATION OF LIABILITY: Consult IPEX Sceptalight™ LED Retrofit Light Engine Specific Terms and Conditions of Sale and Limited Warranty and Limitation of Liability for further details, available at [www.ipexna.com](http://www.ipexna.com)

# SCEPTALIGHT COMPACT FLUORESCENT

Sceptalight Compact Fluorescent fixtures combine the outstanding corrosion and chemical resistance of their thermoplastic design with the energy-saving advantages of compact fluorescents. Working four to five times more efficiently per watt than incandescents, Sceptalight compact fluorescents provide 10-20 times the lamp life. Without sacrificing light levels, they use 75% less energy than incandescents for a lower total energy and maintenance cost. They are available in twin tube and quad tube configurations and include ballast.

## Twin Tubes

- Available in 7, 9 & 13 Watt
- Standard Magnetic Ballast

## Quad Tubes

- Available in 18 & 26 Watt
- Electronic Ballast provides “Instant Start” at temps as low as -25°C
- Offers 10,000 hours of lamp life



## PHOTOMETRIC DATA

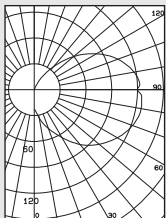

**26W Quad  
Compact  
Flourescent**

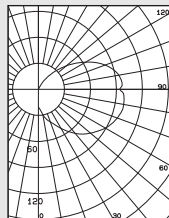

**18W Quad  
Compact  
Flourescent**

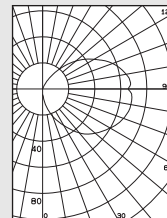

**13W Twin-Tube  
Compact  
Flourescent**

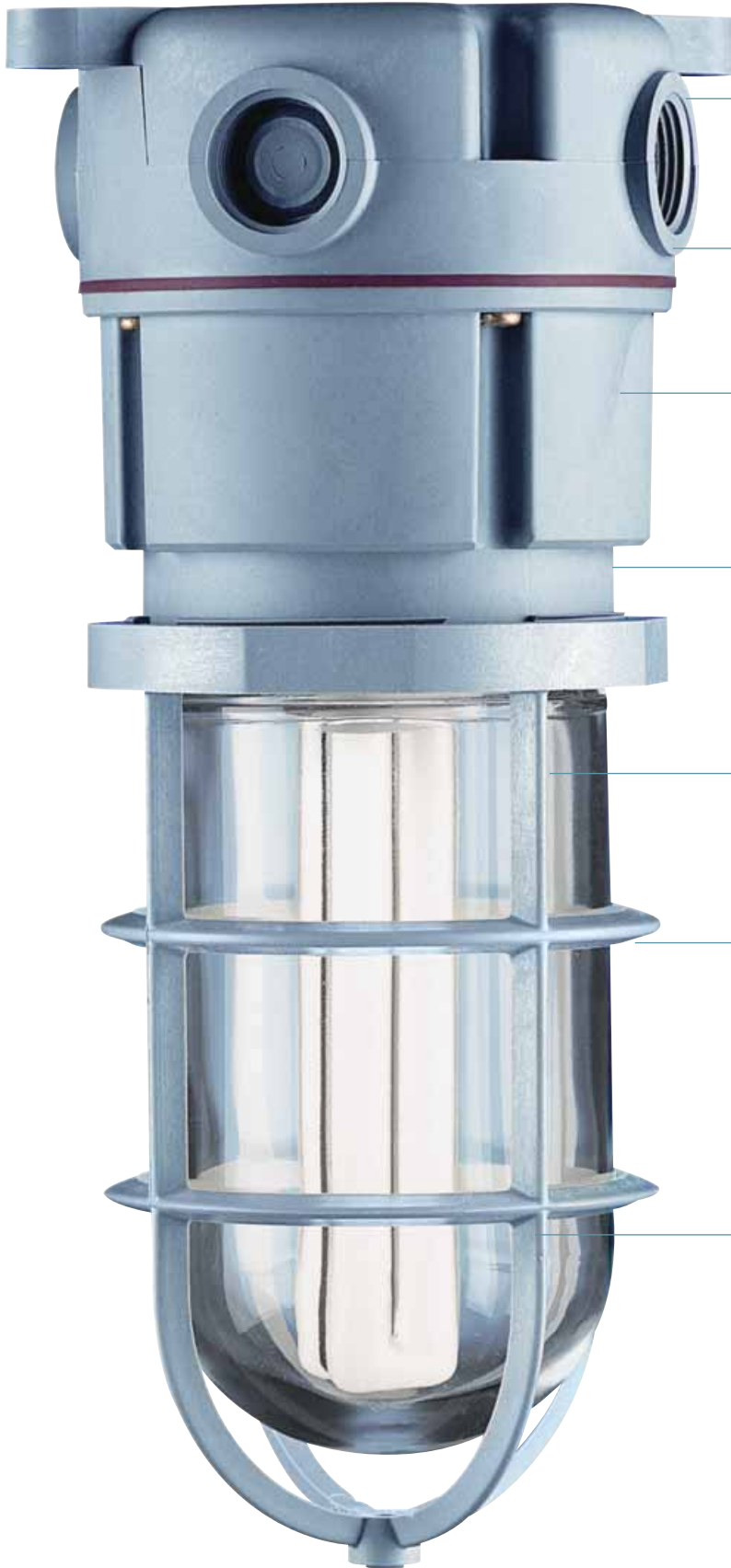

### **STABLE CONSTRUCTION**

Reinforced support feet offer secure mounting.

### **ADAPTABLE**

Threaded conduit hubs permit connection to nonmetallic and metallic raceways.

### **WATERTIGHT SEAL**

Temperature and weather-resistant gaskets protect fixture from moisture penetration.

### **LONG LIFE**

Sceptalight nonmetallic fixtures provide long life and easy servicing—unlike metal fixtures and guards that can corrode and seize together.

### **INDOOR/OUTDOOR USE**

UV-resistant material makes Sceptalight fixtures suitable for both indoor and outdoor use.

### **CORROSION RESISTANT**

Thermoplastic construction resists attack from acids, alcohols, alkalis, organic solvents, detergents/cleaners, greases and oils as well as many other types of chemicals. Withstands exposure to direct sunlight, heat, and extreme weather.

### **DURABLE, IMPACT RESISTANCE**

High-impact nonmetallic guard resists physical impact, chemical attack and heat-induced deformation.

# SCEPTALIGHT INCANDESCENT

Sceptalight incandescent fixtures make the most practical choice to meet the daily needs of commercial, industrial, marine and agricultural applications. Our incandescents will take up to a 150 watt incandescent bulb and are ideal for short burn times as well as flashing and dimming applications.

For light to medium duty applications that do not require the same level of ruggedness, Sceptalight has a low-cost ceiling-mounted Utility Light Fixture available in standard, clear polycarbonate and colored heat-resistant globes.



## PHOTOMETRIC DATA

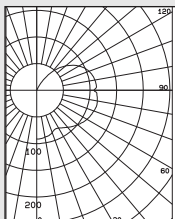

**100W 120V  
Coated A19  
Incandescent**

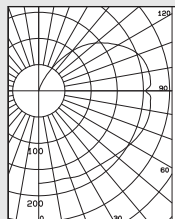

**150W 120V  
Coated A21  
Incandescent**



### **INSTALLATION FLEXIBILITY**

Fixtures can be mounted in ceiling, wall or pendant methods to accommodate installation requirements.

### **INDOOR/OUTDOOR USE**

Temperature and weather-resistant gaskets protect fixture from moisture penetration.

### **COST EFFECTIVE SOLUTION**

Inexpensive to install, the fixture takes up to a 150 watt incandescent bulb.

### **ADAPTABLE LIGHTING ENVIRONMENTS**

Ideal for short burn times, flashing & dimming applications.

### **COLOURED GLOBES AVAILABLE**

Available in a range of coloured heat-resistant globes to transform the light into an indicator or warning light.

### **CORROSION RESISTANT**

Thermoplastic construction withstands exposure to direct sunlight, heat & extreme weather.



## MOUNTING OPTIONS

**Sceptalight LED can be retrofit with Ceiling Mounts only.**

### CEILING MOUNT

Box with four 3/4" threaded hubs and integral mounting feet.

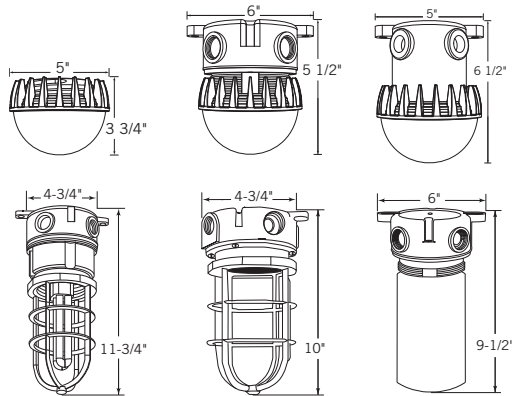

### PENDANT MOUNT

Pendant cap with 3/4" threaded hub and a locking set screw.

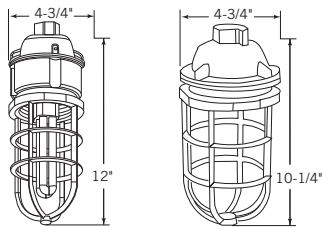

### WALL MOUNT

Box with four 3/4" threaded hubs, 90° wall bracket and integral mounting feet.

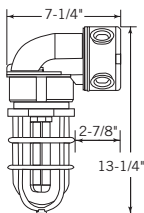

### CEILING MOUNT UTILITY FIXTURES

Box with four 3/4" threaded hubs and integral mounting feet.

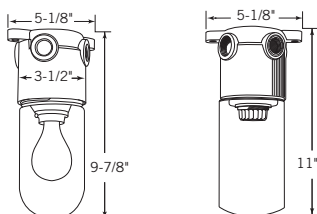

## GLOBE OPTIONS

(For incandescent and fluorescent options only)

### Standard Clear Glass Globes

Ideal for general purpose area lighting for either indoor or outdoor use.

### Clear Polycarbonate Globes

Impact resistant globes for added protection in case of accidental contact.

### Colored Heat-Resistant Glass Globes

Available in red, blue, green or amber – to transform the light to an indicator or warning light.



Clear Polycarbonate



Standard/Heat-treated Clear Glass



Heat-treated Red Glass



Heat-treated Blue Glass



Heat-treated Green Glass



Heat-treated Amber Glass

## ACCESSORIES & COMPONENTS CONT'D

Description	Part Number	Product Code
-------------	-------------	--------------

### Fixture Components (LVPF, LVPL, LPMF, LPPL)

Ceiling Mount Box	LVPB 150	077243
Pendant Mount Cap	LPC 150	077246
90 Wall Bracket	LWB 150	077233
Socket Base Assembly	LSBA 150	077245
Medium Base Replacement Socket	LSOC 150	077249
Screw-on Guard	LVPG 150	077978

### Replacement Lamps

7 Watt	LD/E 7	072841
9 Watt	LD/E 9	072844
13 Watt	LD/E 13	072847
18 Watt (Quad)	LD/E 18	077947
26 Watt (Quad)	LD/E 26	077081

### Replacement Lamp Holders

7/9 Watt Lamp Holder	LLH 7/9	072843
13 Watt Lamp Holder	LLH 13	072849
18 Watt Lamp Holder (4 Pin)	LLH 18	072818
26 Watt Lamp Holder (4 Pin)	LLH 26	077082

### Ballasts

7/9 Watt Magnetic Ballast (NPF)	LEB 7/9	072842
13 Watt Magnetic Ballast (NPF)	LEB 13	072848
18 Watt Electronic Ballast (HPF)	LEB 18	077224
26 Watt Electronic Ballast (HPF)	LEB 26	077080

### Gaskets

Box Gasket	LBGASK 150	072820
Lamp Gasket	LLGASK 150	076971