

Whether you're looking for economical outdoor lighting solutions or corrosion-resistant fixtures for punishing industrial environments, Sceptalight fixtures from IPEX prove themselves to be all-round performers in a variety of indoor and outdoor applications. Sceptalight fixtures are made from a glass-reinforced thermoplastic polyester resin, which enable them to stand up better to corrosive elements than metal. This thermoplastic design marries an unrivaled balance of strength, stiffness and toughness with all the benefits users appreciate of Scepter rigid PVC conduit and fittings – long life, easy servicing and high impact-resistance.

Sceptalight's thermoplastic construction offers outstanding corrosion and chemical resistance. And its interior and exterior silicone gaskets create a watertight seal, the reason it performs equally well indoors and outside.

Wherever you need a lighting fixture that can withstand exposure to chemicals, fluids or harsh physical conditions, you'll find a home for Sceptalight.

Nonmetallic Light Fixtures

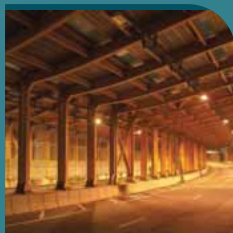

Sceptalight Nonmetallic Light Fixtures

58

SCEPTALIGHT COMPACT FLUORESCENT

Sceptalight Compact Fluorescent fixtures combine the outstanding corrosion and chemical resistance of their thermoplastic design with the energy-saving advantages of compact fluorescents. Working four to five times more efficiently per watt than incandescents, Sceptalight compact fluorescents provide 10-20 times the lamp life. Without sacrificing light levels, they use 75% less energy than incandescents for a lower total energy and maintenance cost. They are available in twin tube and quad tube configurations and include ballast.

Twin Tubes

- Available in 7, 9 & 13 Watt
- Standard Magnetic Ballast

Quad Tubes

- Available in 18 & 26 Watt
- Electronic Ballast provides “Instant Start” at temps as low as -25°C
- Offers 10,000 hours of lamp life



PHOTOMETRIC DATA

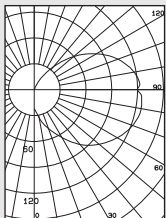

**26W Quad
Compact
Flourescent**

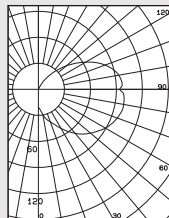

**18W Quad
Compact
Flourescent**

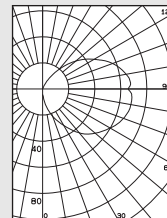

**13W Twin-Tube
Compact
Flourescent**

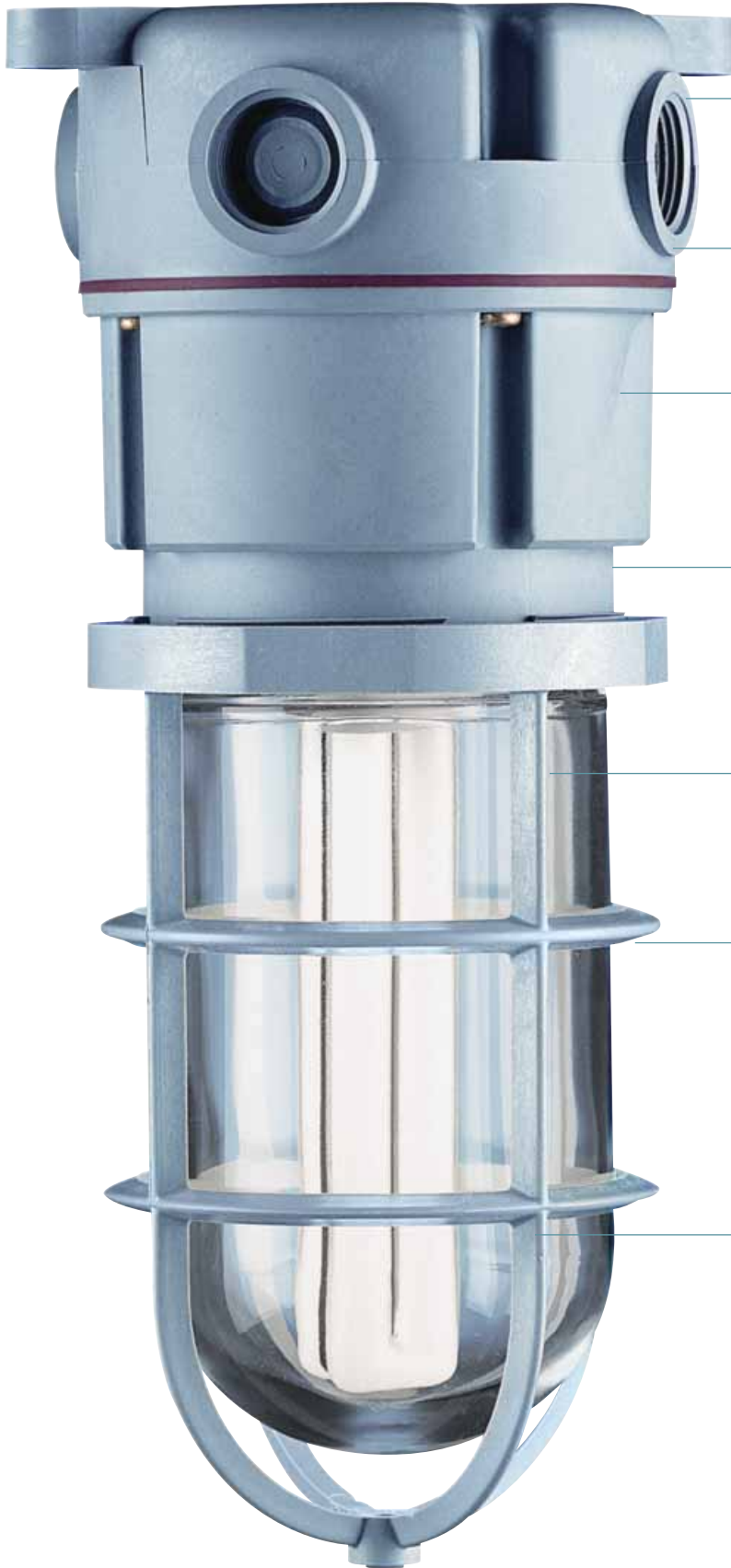

STABLE CONSTRUCTION

Reinforced support feet offer secure mounting.

ADAPTABLE

Threaded conduit hubs permit connection to nonmetallic and metallic raceways.

WATERTIGHT SEAL

Temperature and weather-resistant gaskets protect fixture from moisture penetration.

LONG LIFE

Sceptalight nonmetallic fixtures provide long life and easy servicing—unlike metal fixtures and guards that can corrode and seize together.

INDOOR/OUTDOOR USE

UV-resistant material makes Sceptalight fixtures suitable for both indoor and outdoor use.

CORROSION RESISTANT

Thermoplastic construction resists attack from acids, alcohols, alkalis, organic solvents, detergents/cleaners, greases and oils as well as many other types of chemicals. Withstands exposure to direct sunlight, heat, and extreme weather.

DURABLE, IMPACT RESISTANCE

High-impact nonmetallic guard resists physical impact, chemical attack and heat-induced deformation.

MOUNTING OPTIONS

Sceptalight LED can be retrofit with Ceiling Mounts only.

CEILING MOUNT

Box with four 3/4" threaded hubs and integral mounting feet.

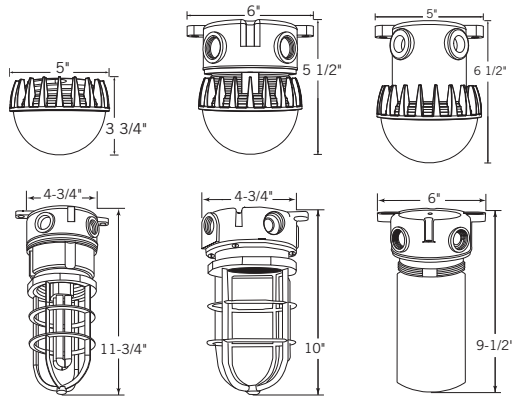

PENDANT MOUNT

Pendant cap with 3/4" threaded hub and a locking set screw.

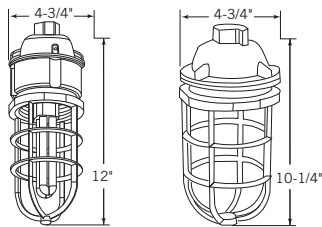

WALL MOUNT

Box with four 3/4" threaded hubs, 90° wall bracket and integral mounting feet.

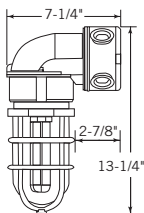

CEILING MOUNT UTILITY FIXTURES

Box with four 3/4" threaded hubs and integral mounting feet.

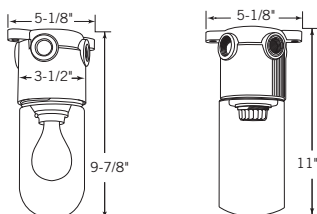

GLOBE OPTIONS

(For incandescent and fluorescent options only)

Standard Clear Glass Globes

Ideal for general purpose area lighting for either indoor or outdoor use.

Clear Polycarbonate Globes

Impact resistant globes for added protection in case of accidental contact.

Colored Heat-Resistant Glass Globes

Available in red, blue, green or amber – to transform the light to an indicator or warning light.



Clear
Polycarbonate



Standard/Heat-treated
Clear Glass



Heat-treated
Red Glass



Heat-treated
Blue Glass



Heat-treated
Green Glass



Heat-treated
Amber Glass

WET LOCATION USE



Description	Part Number	Product Code
-------------	-------------	--------------

Sceptalight LED

15 W LED Retrofit Light Engine	LLED-15	277018
15 W LED LVPF Heavy Duty Light Fixture	LVPF-LED	277074
15 W LED LVPE Utility Light Fixture	LVPE-LED	277075

Ceiling mount with standard clear glass globe

150 W Incandescent	LVPF150C	077225
150 W Incandescent (Less Guard)	LVPF150LG	077237
7 W Compact Fluorescent	LVPL7C	077120
9 W Compact Fluorescent	LVPL9C	077121
13 W Compact Fluorescent	LVPL13C	077122
18 W Compact Fluorescent	LVPL18C	077210
26 W Compact Fluorescent	LVPL26C	077170

Ceiling mount with clear polycarbonate globe (no guard)

7 W Compact Fluorescent	LVPL7PCC	077145
9 W Compact Fluorescent	LVPL9PCC	077155
13 W Compact Fluorescent	LVPL13PCC	077165
18 W Compact Fluorescent	LVPL18PCC	077211
26 W Compact Fluorescent	LVPL26PCC	077176

Pendant mount with standard clear glass globe

150 W Incandescent	LPMF150C	077231
13 W Compact Fluorescent	LPPL13C	077185
18 W Compact Fluorescent	LPPL18C	077212
26 W Compact Fluorescent	LPPL26C	077184

Pendant mount with clear polycarbonate globe (no guard)

7 W Compact Fluorescent	LPPL7PCC	077345
9 W Compact Fluorescent	LPPL9PCC	077355
13 W Compact Fluorescent	LPPL13PCC	077365
18 W Compact Fluorescent	LPPL18PCC	077273
26 W Compact Fluorescent	LPPL26PCC	077375