

NORTH AMERICAN RATED

North American Rated Devices

The Watertight Line. Superior Connection...Superior Protection

5100P7W

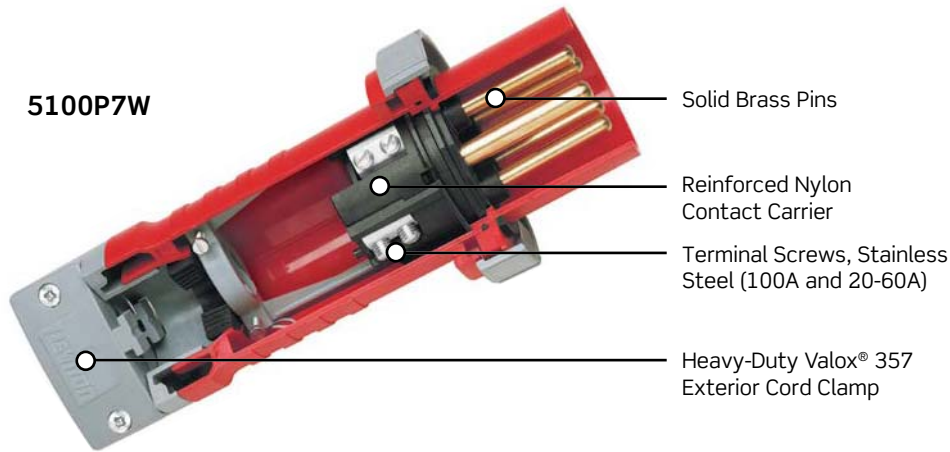

- Solid Brass Pins
- Reinforced Nylon Contact Carrier
- Terminal Screws, Stainless Steel (100A and 20-60A)
- Heavy-Duty Valox® 357 Exterior Cord Clamp



Accepts liquid-tight conduit with adapter accessory (**page G-15**)

5100C7W

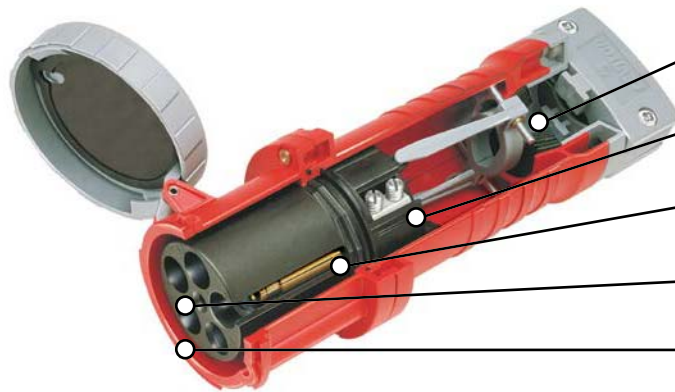

- Watertight Chloroprene Onion Skin Grommet
- Rear Terminals, Raised Lettering Identification
- Calibrated, Self-Adjusting Contacts
- Front Terminals, Raised Lettering Identification
- Super-Durable Valox® 357 Housing and external cord clamp

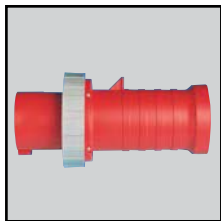

Super Tough Housing

- Provides maximum protection from abuse and environment
- Heavy-wall molding of Valox® 357 resists impact, heat, flame and chemicals
- Superior performance in low-to-high ambient temperature extremes (-40°C to 60°C)
- Excellent UV stability for superior outdoor performance (UL1682)
- V-0 flammability rating
- Fully insulated
- Color-coded by voltage for easy identification

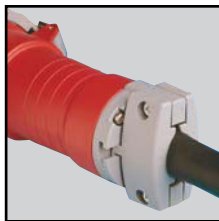

External Cord Clamp

- Protects terminals from strain
- Accommodates a wide variety of cord sizes
- Excellent impact strength
- Excellent UV stability for superior outdoor performance (UL1682)
- V-0 flammability rating
- Accepts wire mesh strain relief



Internal Cord Clamp

- Secondary method for eliminating strain on terminals and conductors
- True IEC 60309-1 & 60309-2 acceptance
- Constructed of sturdy thermoplastic for tough environments
- Removes easily for user convenience



Spring Loaded Cover, Cover Arm, & Locking Rings

- Rings lock plug to connector
- Spring loaded cover closes automatically
- "Performance grade" Stainless Steel cover spring for superior corrosion-resistance and long life
- Excellent UV stability for outdoor use
- V-0 flammability rating
- Interior arm design in 60 and 100 amp helps eliminate breakage



Gasket/Grommet

- Prevents moisture, dust, and contaminants from entering housing or pin/contact carrier
- Solid chloroprene for positive seal and excellent chemical/corrosion-resistance
- Onion skin design on grommet provides precise watertight fit, eliminating the need to choose from multiple grommets that may not fit the cable jacket precisely

Valox® is a registered trademark of SABIC

Features and Benefits

- Rugged housing, made of superior performance Valox® 357, provides maximum corrosion protection and makes the device more resistant to impact, abuse and temperature extremes. V-0 flame rated and superior UV stability
- Contact carrier resists arcing and internal heat build up; 60A and 100A contact/pin carriers are made of reinforced nylon for even greater strength and temperature resistance
- Zinc-coated steel terminal screws on 20A and 30A devices
- Brass terminal screws on 60A devices
- Dependable, clean brass construction for long life, reliable electrical contact, maximum conductivity, and corrosion resistance
- Watertight chloroprene onion skin grommet provides a precise, reliable seal at the cable entry point
- Ground, neutral and phase terminals are clearly identified by color coding or letters and numbering on both front and back sides
- Multiple contact points assure a continuously reliable electrical connection
- Engineered to IP67 watertight and IP69K high-pressure, high-temperature washdown standards
- North American Rated Devices 20A, 30A, 60A and 100A
- Meets North American IEC 60309-1 and 60309-2 Standards
- UL Rated for both 50Hz and 60Hz applications
- Rockwell Automation Encompass™ Product Partner
- Backed by a limited 2-year warranty

Pin & Contact Carrier, 60 & 100 Amp

- Protects pins and contacts, holding them firmly in place
- Pin carrier and contact carrier constructed of glass fiber reinforced nylon for maximum impact resistance and maximum protection of pins and contacts
- Superior arc-tracking resistance
- Excellent heat-resistance and flame resistance
- Chamfered wire entry makes wiring easier

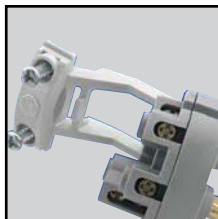
Pin & Contact Carrier, 20 & 30 Amp

- Pin carrier and contact carrier constructed of nylon for maximum impact resistance and maximum protection of pins and contacts
- Terminal screws are aligned on a single plane for easier access
- Internal hinged cord clamp adds strain-relief and swings aside when wiring terminals
- Large diameter combination head terminal screws

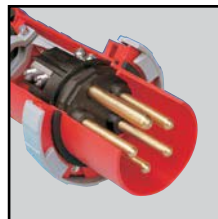
Pins

- Designed for manageable insertion/withdrawal force
- Clean brass construction resists corrosion, provides superior contact and low electrical resistance
- Rounded tips reduce insertion force and decrease wear on the contact surface area

Sleeves (Contacts)

- Designed for manageable insertion/withdrawal force
- Clean brass construction resists corrosion, provides superior contact and low electrical resistance
- Self-adjusting, machine-calibrated contacts for accurate contact pressure designed for superior wiping and cleaning action
- Made from high performance Swedish Industrial Standard (SIS) Brass 5170-04
- Positioned at sleeve entrance, stainless steel spring enables pin cleaning at earliest point of entry

Terminal Screws

- Engineered to provide maximum holding power and lowest electrical resistance
- Accepts a wide range of conductors
- Double screws ensure secure connection
- Direct bearing pressure terminals for 20, 30 and 60 Amp ratings; pressure clamp termination for 100 Amp devices

NORTH AMERICAN RATED | 60A and 100A Watertight
60A and 100A Watertight Pin & Sleeve Devices — North American Rated

Plug — 4100P12W



Connector — 4100C12W



Receptacle — 360R6W



Inlet — 360B7W



Back Box — BX100-V

Features and Benefits

- Engineered to IP67 watertight and IP69K high-pressure, high-temperature washdown standards
- Meet North American IEC 60309-1 and 60309-2 Standards
- Backed by a limited 2-year warranty

60A and 100A Watertight Pin & Sleeve Devices

Amps	Wiring	Voltage AC	Color	Connector/ Receptacle	Plug/ Inlet	Cat. No. Plug	Cat. No. Connector	Cat. No. Receptacle	Cat. No. Inlet	Cat. No. Back Box
60	2p3w	125	Yellow			360P4W	360C4W	360R4W	360B4W	BX60-V
	2p3w	250	Blue			360P6W	360C6W	360R6W	360B6W	BX60-V
	2p3w	480	Red			360P7W	360C7W	360R7W	360B7W	BX60-V
	3p4w	125/250	Orange			460P12W	460C12W	460R12W	460B12W	BX60-V
	3p4w	3Ø250	Blue			460P9W	460C9W	460R9W	460B9W	BX60-V
	3p4w	3Ø480	Red			460P7W	460C7W	460R7W	460B7W	BX60-V
	3p4w	3Ø600	Black			460P5W	460C5W	460R5W	460B5W	BX60-V
	4p5w	3ØY120/208	Blue			560P9W	560C9W	560R9W	560B9W	BX60-V
	4p5w	3ØY277/480	Red			560P7W	560C7W	560R7W	560B7W	BX60-V
4p5w	3ØY347/600	Black			560P5W	560C5W	560R5W	560B5W	BX60-V	
100	2p3w	125	Yellow			3100P4W	3100C4W	3100R4W	3100B4W	BX100-V
	2p3w	250	Blue			3100P6W	3100C6W	3100R6W	3100B6W	BX100-V
	2p3w	480	Red			3100P7W	3100C7W	3100R7W	3100B7W	BX100-V
	3p4w	125/250	Orange			4100P12W	4100C12W	4100R12W	4100B12W	BX100-V
	3p4w	3Ø250	Blue			4100P9W	4100C9W	4100R9W	4100B9W	BX100-V
	3p4w	3Ø480	Red			4100P7W	4100C7W	4100R7W	4100B7W	BX100-V
	3p4w	3Ø600	Black			4100P5W	4100C5W	4100R5W	4100B5W	BX100-V
	4p5w	3ØY120/208	Blue			5100P9W	5100C9W	5100R9W	5100B9W	BX100-V
	4p5w	3ØY277/480	Red			5100P7W	5100C7W	5100R7W	5100B7W	BX100-V
	4p5w	3ØY347/600	Black			5100P5W	5100C5W	5100R5W	5100B5W	BX100-V

Accessories

Valox® Back Boxes — North American Rated



BX230-V



BX100-V
(Same Geometry as BX60-V)

Valox® Back Boxes for Watertight Inlets and Receptacles

Application	Hub Size Used (inches)	Cat. No.
20A & 30A No Adapter Plate Required	1.0	BX230-V
60A Adapter Plate Included	1.5	BX60-V
100A Adapter Plate Included	2.0	BX100-V

Hubs sold separately

Dimensions for Valox® Back Boxes

Description	Unit	A	B	C	D	E	F	G
20A & 30A	inch	6.69"	5.91"	4.53"	3.90"	2.35"	2.35"	0.25"
	mm	170.0	150.0	115.0	99.0	60.0	60.0	6.5
60A	inch	7.68"	6.92"	5.20"	4.65"	2.99"	2.99"	0.31"
	mm	195.0	176.0	132.0	118.0	76.0	76.0	8.0
100A	inch	8.23"	7.39"	6.30"	5.71"	3.99"	3.3"3	0.33"
	mm	209.0	188.0	160.0	145.0	101.0	84.5	8.5

Valox® is a registered trademark of SABIC

Back Boxes

