

Pipe Straps, Conduit Clamps and Hangers

C-727 — Adjustable Swivel Ring

Designed for the support of non-insulated static pipe lines. The swivel nut is knurled to provide a gripping surface when adjusting the pipe elevation.

Specifications

- Compliance: Federal Specification A-A-1192A Type 10, MSS SP-69 Type 10, UL Listed and FM Approved (¾" through 8"). We also offer Swivel Ring hangers that are for Copper Tubing (CT-727), PVC coated (C-727-P) and for NFPA requirements (C-727-NFPA) in this catalog
- Material: Carbon Steel
- Finish: Standard Finish – Pre-Galv, Electro-Galvanized (add suffix "-EG") Black (add suffix "-B")
- Ordering: Specify pipe size, catalog number and finish

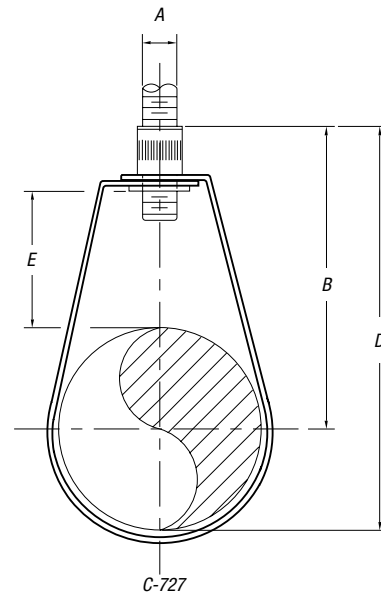

CAT. NO.	PIPE SIZE (IN.)	MAX LOAD (LBS.)	DIMENSIONS (IN.)				WT. EACH (LBS.)
			A	B	D	E	
C-727-1/2	½	300	⅜	2¾	3⅛	1⅛	.09
C-727-¾	¾	300	⅜	2½	3⅛	1⅛	.10
C-727-1	1	300	⅜	2½	3⅛	1	.10
C-727-1-1/4	1¼	300	⅜	2⅜	3⅞	1⅛	.10
C-727-1-1/2	1½	300	⅜	3⅛	3⅞	1⅛	.11
C-727-2	2	300	⅜	3⅞	4⅜	1⅛	.12
C-727-2-1/2	2½	600	½	3⅞	5⅞	1¼	.32
C-727-3	3	600	½	4	5⅞	1⅞	.35
C-727-3-1/2	3½	600	½	4⅞	6⅞	1½	.39
C-727-4	4	1,000	⅝	4⅞	7⅞	1¼	.43
C-727-5	5	1,000	⅝	5⅞	8½	1⅝	.65
C-727-6	6	1,250	¾	6⅞	10⅞	2	1.09
C-727-8	8	1,800	⅞	8⅞	12⅞	2⅝	1.24

Standard Finish: Pre-Galv only.

Add "F" suffix for felt lining.

Pipe Straps, Conduit Clamps and Hangers

C-727-P — PVC-Coated Adjustable Swivel Ring

Designed for the support of non-insulated static pipe lines and to protect the pipe from coming into direct contact with the hanger by having the contact surface PVC coated. The swivel nut is knurled to provide a gripping surface when adjusting the pipe elevation.

Specifications

- Compliance: Federal Specification A-A-1192A Type 10, MSS SP-69 Type 10, UL Listed and FM Approved (¾" through 8")
 - Material: Carbon Steel
 - Finish: Standard Finish — GoldGalv®, Black (add suffix "-B"), Electro-Galvanized (add suffix "-EG")
 - Ordering: Specify pipe size and catalog number
- We also offer Swivel Ring hangers that are for Copper Tubing (CT-727) and for NFPA requirements (C-727-NFPA) in this catalog. Operating temperature should not exceed 140° F/60° C

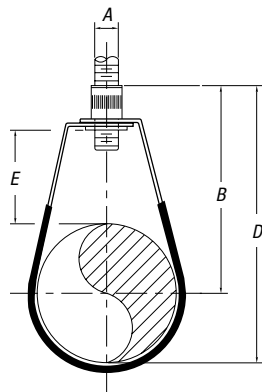

C-727-P

CAT. NO.	PIPE SIZE (IN.)	MAX. LOAD (LBS.)	DIMENSIONS (IN.)				WT. EACH (LBS.)
			A	B	D	E	
C727P 1/2	½	300	¾	2¼	3¼	1¼	.11
C-727-P-3/4	¾	300	¾	2½	3¼	1½	.13
C-727-P-1	1	300	¾	2½	3¼	1	.13
C-727-P-1-1/4	1¼	300	¾	2¾	3¾	1¼	.15
C-727-P-1-1/2	1½	300	¾	3	3¾	1¼	.17
C-727-P-2	2	300	¾	3¼	4¾	1½	.18
C-727-P-2-1/2	2½	600	½	3¾	5¾	1¼	.34
C-727-P-3	3	600	½	4	5¾	1½	.39
C-727-P-3-1/2	3½	600	½	4¾	6¾	1½	.42
C-727-P-4	4	1,000	¾	4¾	7¾	1¼	.48
C-727-P-5	5	1,000	¾	5¾	8¾	1¾	.69
C-727-P-6	6	1,250	¾	6¾	10¾	2	1.13
C-727-P-8	8	1,800	¾	8¾	12¾	2¾	1.29

Standard Finish — GoldGalv®, unless otherwise stated.

C-727-NFPA — NFPA Swivel Ring

Designed for the support of non-insulated static pipe lines. The swivel nut is knurled to provide a gripping surface when adjusting the tubing elevation and is tapped to the reduced rod standards of NFPA.

Specifications

- Compliance: Federal Specification A-A-1192A Type 10, MSS SP-69 Type 10, UL Listed and FM Approved (¾" through 8") and NFPA standards
 - Material: Carbon Steel
 - Finish: Standard Finish — GoldGalv®, Black (add suffix "-B"), Electro-Galvanized (add suffix "-EG")
 - Ordering: Specify pipe size, catalog number and finish
- We also offer Swivel Ring hangers that are for standard commercial pipe (C-727), copper tubing (CT-727) and PVC coated (C-727-P) in this catalog

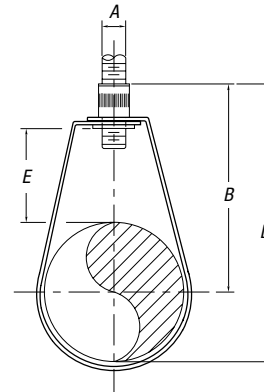

C-727-P

CAT. NO.	PIPE SIZE (IN.)	MAX. LOAD (LBS.)	DIMENSIONS (IN.)				WT. EACH (LBS.)
			A	B	D	E	
C-727-NFPA-1/2	½	300	¾	2¼	3¼	1¼	.09
C-727-NFPA-3/4	¾	300	¾	2½	3¼	1½	.10
C-727-NFPA-1	1	300	¾	2½	3¼	1	.10
C-727-NFPA-1-1/4	1¼	300	¾	2¾	3¾	1¼	.10
C-727-NFPA-1-1/2	1½	300	¾	3	3¾	1¼	.11
C-727-NFPA-2	2	300	¾	3¼	4¾	1½	.12
C-727-NFPA-2-1/2	2½	525	¾	3¾	5	1¼	.25
C-727-NFPA-3	3	525	¾	3¾	5¾	1½	.30
C-727-NFPA-3-1/2	3½	525	¾	4¾	6¾	1½	.33
C-727-NFPA-4	4	650	¾	4¾	7	1¾	.41
C-727-NFPA-5	5	1,000	½	5¾	8¾	2¼	.58
C-727-NFPA-6	6	1,000	½	6¾	9¾	2¾	.92
C-727-NFPA-8	8	1,000	½	7¾	12¼	2¾	1.16

Standard Finish — GoldGalv®, unless otherwise stated.

Pipe Straps, Conduit Clamps and Hangers

CT-727 — Copper Tubing Swivel Ring

Designed for the support of non-insulated static copper tubing lines. The swivel nut is knurled to provide a gripping surface when adjusting the tubing elevation.

Specifications

- Compliance: Federal Specification A-A-1192A Type 10, MSS SP-69 Type 10. We also offer Swivel Ring hangers that are for carbon steel pipe (C-727), PVC coated (C-727-P) and for NFPA requirements (C-727-NFPA) in this catalog
- Material: Carbon Steel
- Finish: Copper
- Ordering: Specify copper tubing size

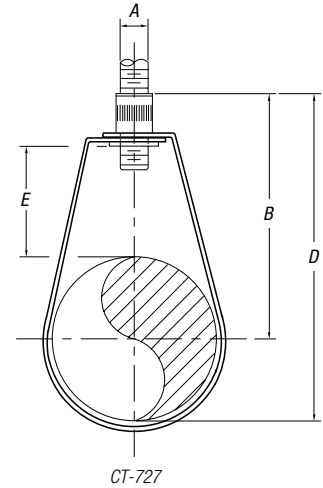

CAT. NO.	PIPE SIZE (IN.)	MAX. LOAD (LBS.)	DIMENSIONS (IN.)				WT. EACH (LBS.)
			A	B	D	E	
CT727 1/2	1/2	300	3/8	2 3/8	3 1/4	1 11/16	.11
CT-727-3/4	3/4	300	3/8	2 3/8	3 1/8	1 3/8	.11
CT-727-1	1	300	3/8	2 1/2	3 1/8	1	.11
CT-727-1-1/4	1 1/4	300	3/8	2 3/4	3 1/4	1 1/16	.13
CT-727-1-1/2	1 1/2	300	3/8	2 15/16	3 3/8	1 1/8	.13
CT-727-2	2	300	3/8	3 3/16	4 1/8	1 1/16	.15
CT-727-2-1/2	2 1/2	525	3/8	4	4 3/8	1 1/8	.16
CT-727-3	3	525	1/2	4 9/16	5 3/16	1 3/16	.32
CT-727-3-1/2	3 1/2	525	1/2	4 9/16	5 5/8	1 1/8	.35
CT-727-4	4	650	1/2	5 5/16	6 1/2	1 3/16	.38
CT-727-5	5	1,000	1/2	6 1/4	8 3/8	1 3/8	.58
CT-727-6	6	1,000	1/2	7 3/16	9 3/16	2 1/4	.92

Standard Finish — GoldGalv® unless otherwise stated.

ET-727 Copper Sized Adjustable Ring

Standard Finish — GoldGalv® barrier for separation of dissimilar metals. Available in sizes 1/2" through 2". Sized for Copper Tubing.

CAT. NO.	TUBING SIZE (IN.)	ROD SIZE (IN.)	DIMENSIONS (IN.)			STOCK SIZE	MAX REC. LOAD (LBS.)	STD. CTN.
			A	B	C			
ET727 1/2	1/2	3/8	3 3/8	2 3/4	1 1/2	16 ga x 3/8	400	100
ET-727-3/4	3/4	3/8	3 1/8	2 5/8	1 1/4	16 ga x 3/8	400	100
ET-727-1	1	3/8	3 3/8	2 1/2	1	16 ga x 3/8	400	100
ET-727-1-1/4	1 1/4	3/8	3 3/4	2 1/2	1	16 ga x 3/8	400	100
ET-727-1-1/2	1 1/2	3/8	3 3/8	3	1 1/4	16 ga x 3/8	400	100
ET-727-2	2	3/8	4 1/2	3 3/8	1 1/2	16 ga x 3/8	400	100
ET-727-2-1/2	2 1/2	3/8*	5 1/2	4 3/8	2	14 ga x 1 3/16	600	100
ET-727-3	3	1/2	6 3/8	4 3/4	2	14 ga x 1 3/16	600	100
ET-727-3-1/2	3 1/2	1/2	6 3/8	4 1/2	1 1/2	14 ga x 1 3/16	600	50
ET-727-4	4	1/2*	7 3/8	5 1/4	2	14 ga x 1 1/4	1,250	100
ET-727-5	5	5/8	8 3/8	5 3/4	2	12 ga x 1 1/4	1,250	25
ET-727-6	6	5/8	9 1/2	6 3/8	1 3/8	12 ga x 1 1/4	1,250	25

2 1/2" CT filled with water weighs less than 2" IP filled with water, 4" CT less than 3 1/2" IP with water.

2 1/2" CT available with 1/2" thread and 4" CT available with 3/8" thread for Government Specs.

Standard Finish — GoldGalv®, unless otherwise stated.

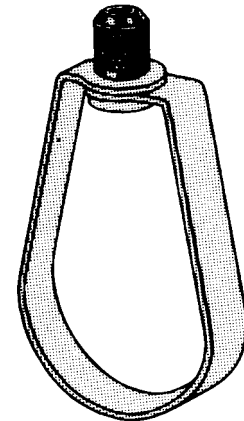

Special Metals and Finishes

Type 304 Stainless Steel Products (SS Suffix) (continued)

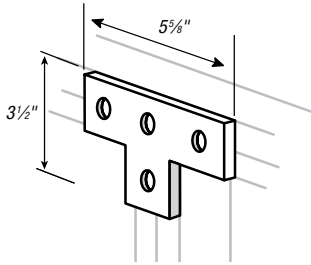

AB220

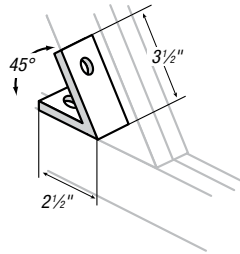

AB225

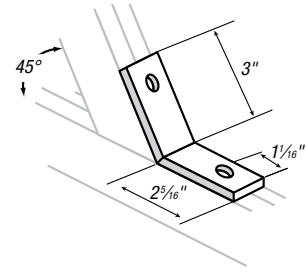

SPAB-227

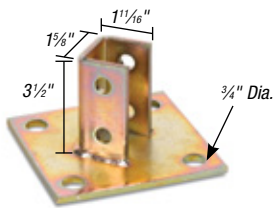

AP-232

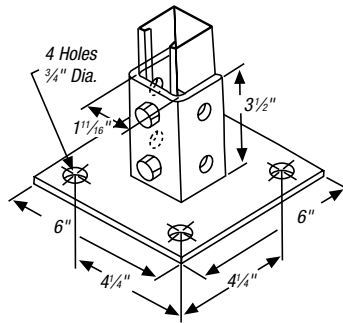

AP-232SQ

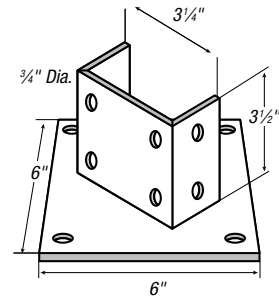

AP-235

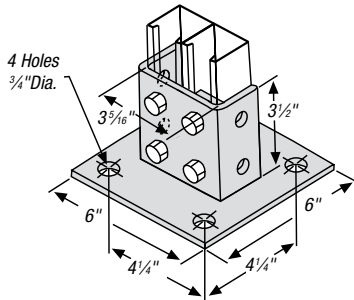

AP-235SQ

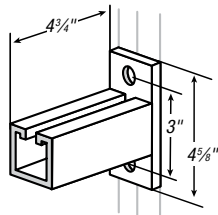

S-250

A is in lengths: 6, 12, 18 & 24.
May be installed inverted with no change
in load ratings. Strut section made from
half slot channel.

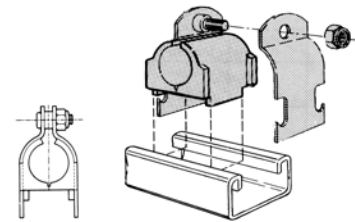

A-716
Cushioned Clamp Tube Series

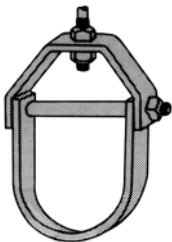

C-710 Series
Standard Clevis

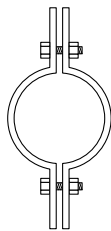

C-720

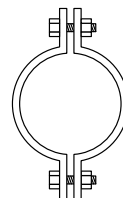

C-725



C-727
Standard Ring Hanger

Technical Information

Federal Specifications (WW-H-171)/ Manufacturers Society Specifications (MSS SP69)



C-710
Adj. Steel Clevis
Sizes 3/4" through 20" IPS
Federal Type 1
SP69 Type 1



C-726
Steel Double Bolt Pipe Clamp
Sizes 1 1/2" through 24" IPS
Federal Type 3
SP69 Type 3



C-725
Steel Pipe Clamp
Sizes 1 1/2" through 24" IPS
Federal Type 4
SP69 Type 4



CF-710
Adj. Steel Band Hanger
Sizes 1/2" through 8"
IPS 3/4" through 4" tube
Federal Type 7

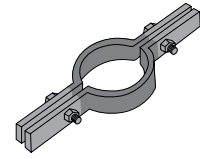

C-720/CT-720
Extension Pipe or Riser Clamp
Sizes 3/4" through 20"
IPS 1/2" through 6" tube
Federal Type 8
SP69 Type 8



C-727/CT-727
Adj. Swivel Ring Hanger
Sizes 1/2" through 8" IPS
1/2" through 4" tube
Federal Type 10
SP69 Type 10

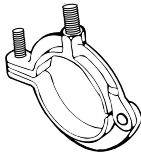

M-718/MT-718
MI Split Pipe Ring
w/wo turnbuckle adj.
Sizes 1/2" through 8" IPS
1/2" through 4" tube
Federal Type 11
SP69 Type 12



CL-710
Light-Duty Clevis Hanger
Sizes 1/2" through 4"
Federal Type 12



F-112
Forged Steel Turnbuckle
Sizes 3/8" through 1 1/2" rod
Federal Type 13
SP69 Type 13



F-111
Forged Steel Clevis
Sizes 3/8" through 1 1/2" rod
Federal Type 14
SP69 Type 13

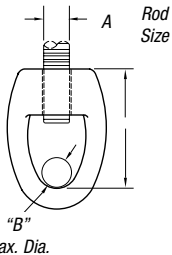

M-117
MI Socket only for
S Split Ring Hanger
Sizes 3/8" through 1 1/2" Rod
Federal Type 16
SP69 Type 16



E-120-A
Forged Steel Weldless Eye Nut
Sizes 3/8" through 1 1/2" rod
Federal Type 17
SP69 Type 17

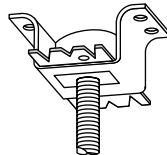

452
Steel Concrete Insert
Federal Type 19
SP69 Type 18

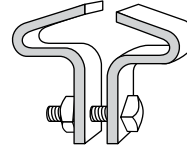

C-755 T/C-757 T
Center I-Beam Clamp
Federal Type 21
SP69 Type 21

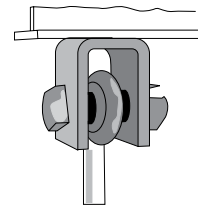

C-780
Welded attachment as
shown or inverted less bolt
Federal Type 22
SP69 Type 22



M-775-L/C-775-L
MI or Steel C-Clamp
Sizes 3/8" through 1 1/2"
Federal Type 23
SP69 Type 23



H-115
U-Bolt
Sizes 1/2" through 24" IPS
Federal Type 24
SP69 Type 24

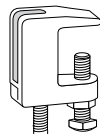

M-778
Top Beam C-Clamp
Sizes 3/8" through 3/4" rod
SP69 Type 19

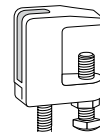

M-777
Junior Top Beam C-Clamp
Sizes 3/8" through 1/2" rod
SP69 Type 18

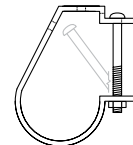

C-711
"J" Pipe Hanger
Sizes 1/2" through 8" pipe
SP69 Type 5