

Conduit, Cable and Pipe Supports

Kindorf® Straps for O.D. Tubing



701-3/4

CAT. NO.	TUBING O.D. (IN.)	STEEL STRAP THICKNESS	DESIGN LOAD (LBS.)
Galv-Krom® Finish			
701 1/4	¼	14 ga.	750
701-3/8	⅜	14 ga.	750
701-1/2-STR	½	14 ga.	750
701-5/8	⅝	14 ga.	750
701-3/4	¾	14 ga.	750
701-7/8	⅞	14 ga.	750
701-1-STR	1	14 ga.	750
701-1-1/8	1⅛	14 ga.	1,000
701-1-1/4	1¼	14 ga.	1,000
701-1-3/8	1⅜	14 ga.	1,000
701-1-1/2	1½	14 ga.	1,000
701-1-5/8	1⅝	14 ga.	1,000
701-1-3/4	1¾	12 ga.	1,000
701-1-7/8	1⅞	12 ga.	1,000
701-2	2	12 ga.	1,000
701-2-1/8	2⅛	12 ga.	1,300
701-2-1/4	2¼	12 ga.	1,300
701-2-3/8	2⅜	12 ga.	1,300
701-2-1/2	2½	12 ga.	1,300
701-2-5/8	2⅝	12 ga.	1,300
701-2-3/4	2¾	12 ga.	1,300
701-2-7/8	2⅞	12 ga.	1,300
701-3	3	12 ga.	1,300
701-3-1/8	3⅛	12 ga.	1,300
701-3-1/4	3¼	12 ga.	1,300
701-3-3/8	3⅜	12 ga.	1,300
701-3-1/2	3½	12 ga.	1,300
701-3-5/8	3⅝	11 ga.	1,650
701-3-3/4	3¾	11 ga.	1,650
701-3-7/8	3⅞	11 ga.	1,650

For SilverGalv® Finish, add suffix EG.

CAT. NO.	TUBING O.D. (IN.)	STEEL STRAP THICKNESS	DESIGN LOAD (LBS.)
Galv-Krom® Finish			
701-4	4	11 ga.	1,650
701-4-1/8	4⅛	11 ga.	1,650
701-4-1/4	4¼	11 ga.	1,650
701-4-3/8	4⅜	11 ga.	1,650
701-4-1/2	4½	11 ga.	1,650
701-4-5/8	4⅝	11 ga.	1,650
701-4-3/4	4¾	11 ga.	1,650
701-4-7/8	4⅞	11 ga.	1,650
701-5	5	11 ga.	1,650
701-5-1/8	5⅛	11 ga.	1,650
701-5-1/4	5¼	11 ga.	1,650
701-5-3/8	5⅜	11 ga.	1,650
701-5-1/2	5½	11 ga.	1,650
701-5-5/8	5⅝	10 ga.	1,650
701-5-3/4	5¾	10 ga.	1,650
701-5-7/8	5⅞	10 ga.	1,650
701-6	6	10 ga.	1,650
701-6-1/8	6⅛	10 ga.	1,650
701-6-1/4	6¼	10 ga.	1,650
701-6-3/8	6⅜	10 ga.	1,650
701-6-1/2	6½	10 ga.	1,650
701-6-5/8	6⅝	10 ga.	1,650
701-6-3/4	6¾	10 ga.	1,650
701-6-7/8	6⅞	10 ga.	1,650
701-8	8	10 ga.	1,650

For SilverGalv® Finish, add suffix EG.

C-708-U Short Strap for Channel or Wall Mounting

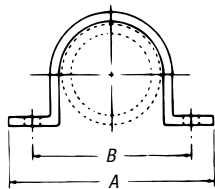
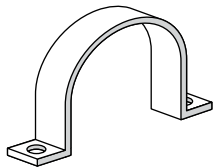

CAT. NO.	PIPE SIZE (IN.)	DIMENSIONS (IN.)		HOLE SIZE (IN.)	STOCK SIZE (IN.)	DESIGN LOAD (LBS.)
		A	B			
C708U 1/2	½	2⅞	2	⅜	⅜ x 1⅜	650
C-708-U-3/4	¾	3⅞	2⅞	⅜	⅜ x 1⅜	650
C-708-U-1	1	3⅞	2½	⅜	⅜ x 1⅜	650
C-708-U-1-1/4	1¼	3⅞	2⅞	⅜	⅜ x 1⅜	650
C-708-U-1-1/2	1½	3⅞	3⅞	⅜	⅜ x 1⅜	650
C-708-U-2	2	5¼	4⅞	⅞	¼ x 1⅜	650
C-708-U-2-1/2	2½	6⅞	4⅞	⅞	¼ x 1⅜	1,000
C-708-U-3	3	6⅞	5⅞	⅞	¼ x 1⅜	1,000
C-708-U-3-1/2	3½	7⅞	5⅞	⅞	¼ x 1⅜	1,000
C-708-U-4	4	7⅞	6⅞	⅞	¼ x 1⅜	1,200
C-708-U-5	5	8⅞	7¼	⅞	¼ x 1⅜	1,200
C-708-U-6	6	9⅞	8⅞	⅞	¼ x 1⅜	1,200

Overview

Finishes (continued)

GoldGalv®

The standard GoldGalv® finish is made up of a multi-step electrogalvanizing and zinc trivalent chromium process. The trivalent chromium finish is applied over the zinc, producing a chemically bonded non-porous barrier for protection from moisture and air. The .5 mil electro-plated zinc and gold trivalent chromium finish provides all of the features and protection of hexavalent chromium without the use of the chemical.

SilverGalv® (Suffix EG)

Often referred to as “zinc plated” or “electroplated zinc,” the steel and .5 mils of zinc are bonded by an electrolysis process. This is the identical process used in the Superstrut Goldgalv® finish without the numerous benefits of the gold-colored trivalent chromium conversion coat (see GoldGalv® finish for more information). Electrogalvanizing is most commonly applied to small fittings, hardware and threaded products.

Green or White Urethane Powder Coated (Suffix GR or WH)

Urethane powder resins are applied electrostatically to the steel after fabrication. Once the material is completely covered with the powder-form urethane, it proceeds through a 400° baking process for ten minutes, creating a chemical bond. This results in a minimum of 1.5 mil thickness of urethane coating, providing excellent resistance to chipping or peeling.

Pregalvanized (Suffix PG)

A zinc coating is applied by hot-dipping the steel coil at the mill prior to fabrication. Once the material is worked by roll-forming, cutting or punching, minimal protection is provided for raw edges. This weakness is typical with precoated material and affects the channel section around holes, extreme ends and the edges of the “U” shape lips. Superstrut pregalvanized material is in conformance with ASTM A-525/G-90 specification standards, representing 0.90 ounces of zinc per square foot of steel. This finish is often referred to as “hot-dipped mill galvanized” or “mill galvanized.”

Hot-Dipped Galvanized (Suffix HDG)

The material is zinc coated after fabrication, providing total product protection on all surfaces. The fabricated channel or fitting is suspended and then dipped into tanks of hot zinc for a prolonged period, creating a coherent bond. The result is superior corrosion resistance as compared to pregalvanized material. Hot-dipped galvanizing is not recommended for threaded products, because the thickness of the zinc coating will often disrupt the threads. Superstrut hot-dipped galvanized is in conformance with ASTM Specifications A-123 (formerly A-386) and A-153. Superstrut channels maintain a minimum 1.5 ounces of zinc per square foot of steel or 2.5 mils (ASTM A-123, Thickness Grade 65). This finish is also referred to as “hot-dipped galvanized after fabrication.”

PVC Coated (Suffix PVC)

A polyvinyl chloride (PVC) plastic coating is fused to the channel, fitting or accessory after fabrication by immersing the part in fluidized PVC tanks. The fused-melt mixed powder PVC coating thickness is 15 mils (.015”) plus or minus five mils. PVC material is a thermoplastic and will soften in high temperature. An inherent weakness with PVC coatings occurs when field alterations are applied, such as cutting or drilling. These acts disrupt the sealed PVC product and warrant field touch-up. Thomas & Betts cannot be held responsible for field-altered PVC coated products.

Copper Plated (“T” inserted as the second digit of the part number; Example: CTL-710-2)

Plain steel proceeds through a series of rinse tanks to clean the material surface. Once cleaned, the fabricated part is etched by dipping into an acid pickle bath to prepare the surface for adhesion. Copper is electrically applied by submerging in a copper bath. To seal the finish, the product continues to a sealer tank and is then dried by forced hot air.

Black (Suffix B)

A black finish is raw steel with only a light oil finish as supplied by the steel manufacturer. There is no protection against red rust.

Stainless Steel (Suffix SS)

Superstrut channel is supplied in type 304 stainless steel when required. Type 316 stainless steel may be available upon request.

Aluminum (Suffix AL)

Superstrut channel and hardware are available in aluminum.

Warning: Load tables, charts and design criteria provided in this catalog are intended as guides only. Selection of proper product, installation intervals, erection and placement are the responsibility of the user.

Superstrut® products are intended to be used for the support and bracing of fixtures, cable, pipe and conduit. Improper use or installation may result in injury to persons or damage of property.

Material and finish specifications are subject to change without notice.



Pipe Straps, Conduit Clamps and Hangers

C-716 — Isolator for Copper Tubing

Features:

Designed for use with Superstrut® channel and pipe straps and Superstrut® C-711 Hangers, and may also be used with all standard flatbar or malleable iron hangers.

Materials:

Manufactured from one-piece steel shell with reinforcing ribs for stiffening and alignment. Padding is of processed non-conducting hairfelt and is cemented to the metal. Design of ribs creates a hinge so isolator may be opened and closed to install.

Application:

To provide a means to effectively isolate copper tubing from its supports to prevent the transmission of sound and vibration.

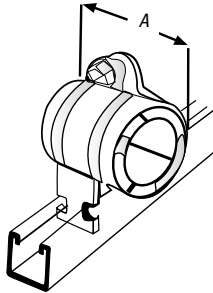

CAT. NO.	SIZE (IN.)	NOMINAL PIPE SIZE (IN.)	HANGER, C-711 OR PIPE STRAP, 702	WIDTH A (IN.)	STD. CTN.
C716 1/2	1/2	1/2	3/4	2 5/8	100
C-716-3/4	3/4	3/4	3/4	2 5/8	100
C-716-1	1	1	1	2 5/8	100
C-716-1-1/4	1 1/4	1 1/4	1 1/4	2 5/8	50
C-716-1-1/2	1 1/2	1 1/2	1 1/2	2 5/8	50
C-716-2	2	2	2 1/2	2 5/8	50
C-716-2-1/2	2 1/2	2 1/2	3	2 15/32	50
C-716-3	3	3	3 1/2	2 5/8	50
C-716-3-1/2	3 1/2	3 1/2	4	4 1/4	30
C-716-4	4	4	5	4 1/4	20

Order by Cat. No. and size.
Standard Finish — GoldGalv®

S716 — Cushioned Strip — For Isolation and Vibration Applications

For use with 701 O.D. tubing and pipe clamp. To determine 701 clamp size, add 1/4" to O.D. tube size to allow for the cushioned strip material.

1/4" markings for fast measuring and cutting. Measurement chart is printed on back of carton. 20 feet included in each carton.

Prevent metal-to-metal contact with the cushioned strip material. It aids in sound insulation, shock absorption and protects against corrosion, distortion and abrasion. Cushioned strip material is designed for optimal use between -30° F and 300° F. Cushioned strip material combined with the Superstrut® 701 pipe strap can handle clamping assignments from 1/4" to 6."

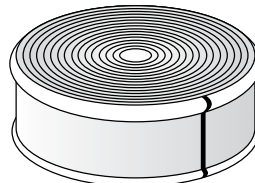

S716

Sold in a carton of 20 feet.

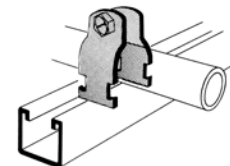

Order 701 clamp separately.

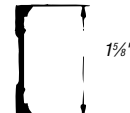
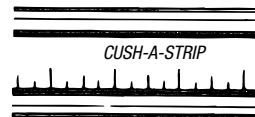

C-708-U — Short Strap for Channel or Wall Mounting

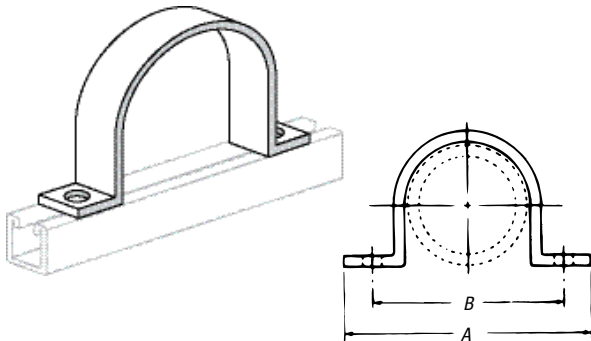

CAT. NO.	PIPE SIZE	DIMENSIONS (IN.)			STOCK SIZE	DESIGN LOAD LBS.	STD. CTN.
		A	B	HOLE SIZE			
C-708-U-1/2	1/2	2 1/8	2	5/32	1/8 x 1 1/8	650	50
C-708-U-3/4	3/4	3 1/16	2 3/16	5/32	1/8 x 1 1/8	650	50
C-708-U-1	1	3 3/8	2 1/2	5/32	1/8 x 1 1/8	650	50
C-708-U-1-1/4	1 1/4	3 11/16	2 3/16	5/32	1/8 x 1 1/8	650	25
C-708-U-1-1/2	1 1/2	3 15/16	3 1/16	5/32	1/8 x 1 1/8	650	25
C-708-U-2	2	5 3/4	4 1/8	7/16	1/4 x 1 5/8	650	25
C-708-U-2-1/2	2 1/2	6 3/16	4 9/16	7/16	1/4 x 1 5/8	1,000	25
C-708-U-3	3	6 3/16	5 3/16	7/16	1/4 x 1 5/8	1,000	25
C-708-U-3-1/2	3 1/2	7 7/16	5 11/16	7/16	1/4 x 1 15/32	1,000	25
C-708-U-4	4	7 13/16	6 3/16	7/16	1/4 x 1 15/32	1,200	25
C-708-U-5	5	8 7/8	7 1/4	7/16	1/4 x 1 15/32	1,200	10
C-708-U-6	6	9 15/16	8 3/16	7/16	1/4 x 1 15/32	1,200	10

Carbon Steel.
Standard Finish — GoldGalv®