

Fittings and Brackets

Fittings and Brackets — Series 200



Material

Superstrut® fittings and brackets are manufactured from hot rolled carbon steel.

Dimensions

The following standard dimensions apply to all fittings except as indicated on the individual drawings.

- Hole spacing: $\frac{13}{16}$ " from end of fittings
- Hole spacing: $1\frac{1}{8}$ " centers
- Hole size: $\frac{9}{16}$ " diameter
- Material: $1\frac{1}{8}$ " wide
- Material: $\frac{1}{4}$ " thickness

Application Instructions

Parts drawings illustrate a typical use for the fitting, and in many cases other uses for the part are appropriate.

Design Data

Ratings vary when used with 12 or 14 gauge channel and are shown for each channel material.

GoldGalv® hardware finish is standard for all Superstrut® products. This is a multi-process finish of electro-plated zinc, followed by gold-colored trivalent chromium to give excellent corrosion resistance and a superior paint base. See **pages B-106–B-107** for complete description of the GoldGalv® hardware finish. GoldGalv® hardware will be furnished if no other finish is specified.

Nuts and Bolts Required

Unless otherwise noted, nuts and bolts for use with fittings and brackets should be ordered separately.

The standard bolt for the $\frac{9}{16}$ " hole is a $\frac{1}{2}$ " hex head cap screw $1\frac{5}{16}$ " long. The $1\frac{5}{16}$ " length may be used with all series channel.

Standard Finish – GoldGalv®, unless otherwise stated.

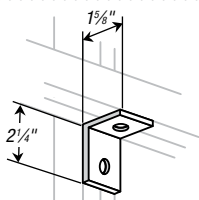

CAT. NO. AB201

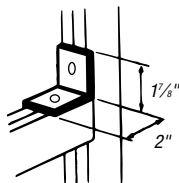

CAT. NO. AB202

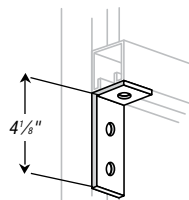

CAT. NO. AB203

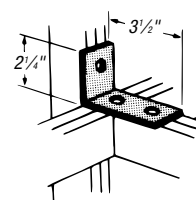

CAT. NO. AB204

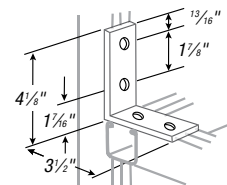

CAT. NO. AB205

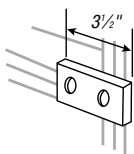

CAT. NO. AB206

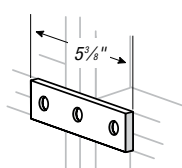

CAT. NO. AB207

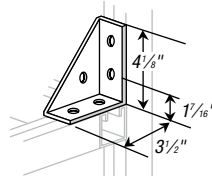

CAT. NO. AB213

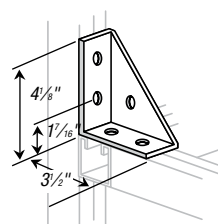

CAT. NO. AB214

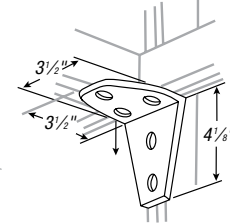

CAT. NO. AB216

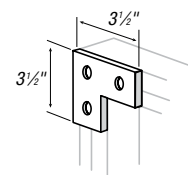

CAT. NO. AB219

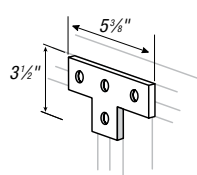

CAT. NO. AB220

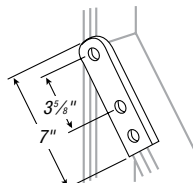

CAT. NO. AB240

Standard Dimensions

- Hole Spacing: $\frac{13}{16}$ " From End
- Hole Spacing: $1\frac{1}{8}$ " Centers
- Hole Size: $\frac{9}{16}$ " Diameter
- Material: $1\frac{1}{8}$ " Width
- Material: $\frac{1}{4}$ " Thick

Standard Finish – GoldGalv®, unless otherwise stated.
Add EG suffix for SilverGalv® Finish

Fittings and Brackets

Special Application Fittings

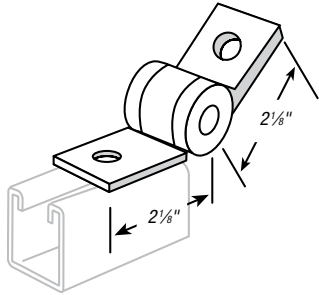

CAT. NO. Q202

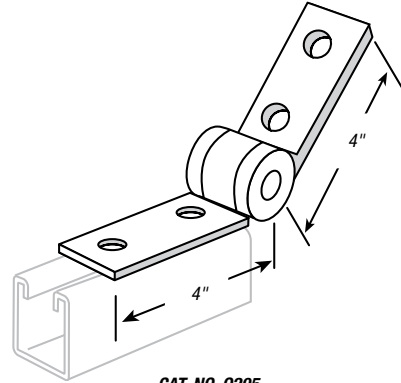

CAT. NO. Q205

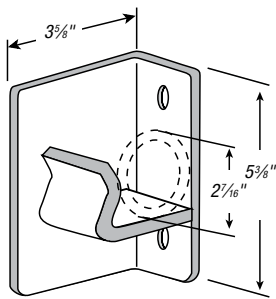

CAT. NO. Q255
For 2" standard pipe.
Load 1,500 lbs.

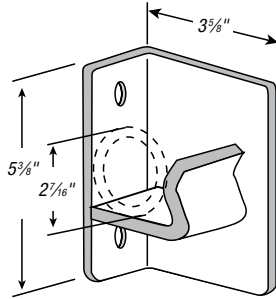

CAT. NO. Q256
For 2" standard pipe.
Load 1,500 lbs.

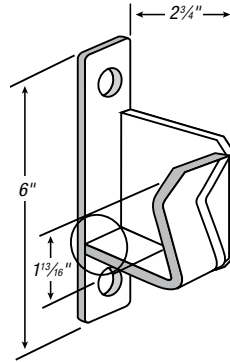

CAT. NO. Q253
For 1 1/4" standard pipe.
Load 1,500 lbs.

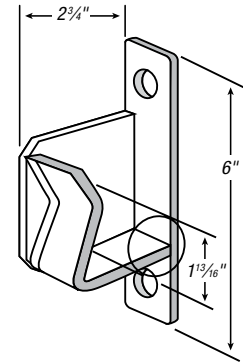

CAT. NO. Q254
For 1 1/4" standard pipe.
Load 1,500 lbs.

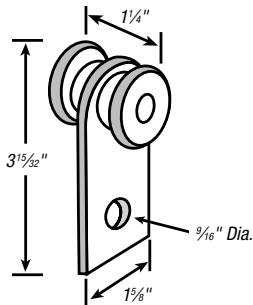

CAT. NO. TR292
Frictionless needle bearings.
Design load: 500 lbs.
Safety factor of 5.

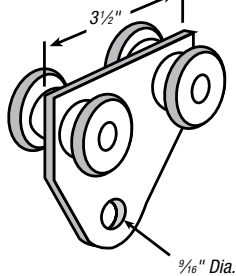

CAT. NO. TR294
Frictionless needle bearings.
Design load: 1,000 lbs.
Safety factor of 5.

.....Standard Dimensions.....

- Hole Spacing: 1 3/16" From End
- Hole Spacing: 1 7/8" Centers
- Hole Size: 9/16" Diameter
- Material: 1 5/8" Width
- Material: 1/4" Thick

Standard Finish – GoldGalv®, unless otherwise stated.
Add EG suffix for SilverGalv® Finish

Overview

Finishes (continued)

GoldGalv®

The standard GoldGalv® finish is made up of a multi-step electrogalvanizing and zinc trivalent chromium process. The trivalent chromium finish is applied over the zinc, producing a chemically bonded non-porous barrier for protection from moisture and air. The .5 mil electro-plated zinc and gold trivalent chromium finish provides all of the features and protection of hexavalent chromium without the use of the chemical.

SilverGalv® (Suffix EG)

Often referred to as “zinc plated” or “electroplated zinc,” the steel and .5 mils of zinc are bonded by an electrolysis process. This is the identical process used in the Superstrut Goldgalv® finish without the numerous benefits of the gold-colored trivalent chromium conversion coat (see GoldGalv® finish for more information). Electrogalvanizing is most commonly applied to small fittings, hardware and threaded products.

Green or White Urethane Powder Coated (Suffix GR or WH)

Urethane powder resins are applied electrostatically to the steel after fabrication. Once the material is completely covered with the powder-form urethane, it proceeds through a 400° baking process for ten minutes, creating a chemical bond. This results in a minimum of 1.5 mil thickness of urethane coating, providing excellent resistance to chipping or peeling.

Pregalvanized (Suffix PG)

A zinc coating is applied by hot-dipping the steel coil at the mill prior to fabrication. Once the material is worked by roll-forming, cutting or punching, minimal protection is provided for raw edges. This weakness is typical with precoated material and affects the channel section around holes, extreme ends and the edges of the “U” shape lips. Superstrut pregalvanized material is in conformance with ASTM A-525/G-90 specification standards, representing 0.90 ounces of zinc per square foot of steel. This finish is often referred to as “hot-dipped mill galvanized” or “mill galvanized.”

Hot-Dipped Galvanized (Suffix HDG)

The material is zinc coated after fabrication, providing total product protection on all surfaces. The fabricated channel or fitting is suspended and then dipped into tanks of hot zinc for a prolonged period, creating a coherent bond. The result is superior corrosion resistance as compared to pregalvanized material. Hot-dipped galvanizing is not recommended for threaded products, because the thickness of the zinc coating will often disrupt the threads. Superstrut hot-dipped galvanized is in conformance with ASTM Specifications A-123 (formerly A-386) and A-153. Superstrut channels maintain a minimum 1.5 ounces of zinc per square foot of steel or 2.5 mils (ASTM A-123, Thickness Grade 65). This finish is also referred to as “hot-dipped galvanized after fabrication.”

PVC Coated (Suffix PVC)

A polyvinyl chloride (PVC) plastic coating is fused to the channel, fitting or accessory after fabrication by immersing the part in fluidized PVC tanks. The fused-melt mixed powder PVC coating thickness is 15 mils (.015”) plus or minus five mils. PVC material is a thermoplastic and will soften in high temperature. An inherent weakness with PVC coatings occurs when field alterations are applied, such as cutting or drilling. These acts disrupt the sealed PVC product and warrant field touch-up. Thomas & Betts cannot be held responsible for field-altered PVC coated products.

Copper Plated (“T” inserted as the second digit of the part number; Example: CTL-710-2)

Plain steel proceeds through a series of rinse tanks to clean the material surface. Once cleaned, the fabricated part is etched by dipping into an acid pickle bath to prepare the surface for adhesion. Copper is electrically applied by submerging in a copper bath. To seal the finish, the product continues to a sealer tank and is then dried by forced hot air.

Black (Suffix B)

A black finish is raw steel with only a light oil finish as supplied by the steel manufacturer. There is no protection against red rust.

Stainless Steel (Suffix SS)

Superstrut channel is supplied in type 304 stainless steel when required. Type 316 stainless steel may be available upon request.

Aluminum (Suffix AL)

Superstrut channel and hardware are available in aluminum.

Warning: Load tables, charts and design criteria provided in this catalog are intended as guides only. Selection of proper product, installation intervals, erection and placement are the responsibility of the user.

Superstrut® products are intended to be used for the support and bracing of fixtures, cable, pipe and conduit. Improper use or installation may result in injury to persons or damage of property.

Material and finish specifications are subject to change without notice.

