

# CABLESMART® 40N2 SERIES RACEWAY

Two-Piece, Dual-Channel, Large



Two-piece, dual-channel, large raceway. Lightweight and easy-to-install. Ideal for both power and communication installations.

## CODE REFERENCE

**cULus Listed Raceway:**  
File E90378 Guide RJTX.  
Complies with flammability requirements of UL-5A.

**Fittings:** File E90377 Guide RJYT.  
Meets Article 388 of NEC.  
UL Listed for up to 600V.  
Meets Section 12-1600 of CEC.

## CableSmart 40N2 Series Raceway System Layout

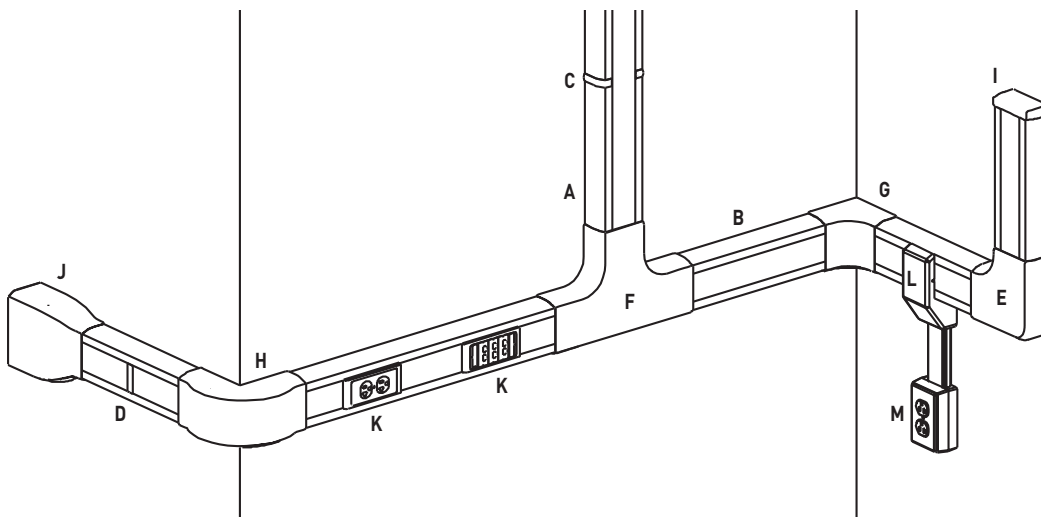

**NOTE:** Illustration is for showing product applications only.

## KEY

- |                                   |                                       |   |
|-----------------------------------|---------------------------------------|---|
| A. 40N2B08 Raceway Base           | F. 40N2F15 Bend Radius Tee            | J. 40N2F21 Divided Entrance End Fitting |
| B. 40N2C08 Raceway Cover          | G. 40N2F17 Bend Radius Internal Elbow | K. 40N2F31 Twin Cover Device Bracket    |
| C. 40N2F05 Base Clip              | H. 40N2F19 Bend Radius External Elbow | L. 40N2F74 Divided Transition Fitting   |
| D. 40N2F06 Cover Clip             | I. 40N2F20 Blank End Fitting          | M. PSB1 One-Gang Device Box             |
| E. 40N2F11 Bend Radius Flat Elbow |                                       |   |

## COLOR OPTIONS



Cablesmart® 40N2 Series Raceway Part Numbers with a "V" suffix are available in an ivory finish. Part Numbers with a "WH" suffix have a white finish. 40N2 Series Raceway is paintable using latex paint or stain.

**Custom color options are also available. Consult the factory for more information.**

# CABLESMART® 40N2 SERIES RACEWAY

## Ordering Information

### Cablesmart 40N2 Series Raceway Interconnectivity Fittings

CONNECTION REQUIRED FROM	TO	USE CATALOG NUMBER
1/2" or 3/4" trade size Conduit	40N2 Series Raceway	40N2F20
3/4", 1", 1 1/4" & 1 1/2" trade size conduit or armored cable	40N2 Series Raceway	40N2F21
40N2 Series Raceway	PN03, PN05, PN10 Series Raceways	40N2F74

### 40N2F11 Radiused Full Capacity Flat Elbow

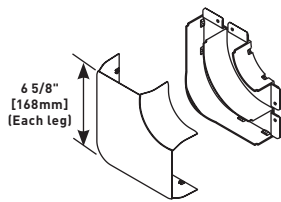

A 90° flat corner with integral dividers to provide 2" [51mm] cable bend radius for UTP and fiber optic installations. Ideal for lay-in or pull-through installations. Available in ivory (40N2F11V) or white (40N2F11WH).

### 40N2F15 Radiused Full Capacity Tee

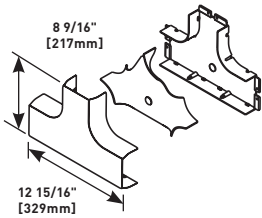

For branches at right angles. A full capacity tee fitting that provides separation of cable bend radius for UTP and fiber optic installations. Available in ivory (40N2F15V) or white (40N2F15WH).

### 40N2F17 Radiused Full Capacity Internal Elbow

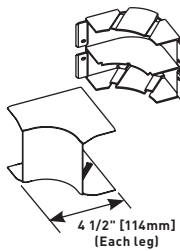

A 90° internal corner with integral dividers to provide 2" [51mm] cable bend radius for UTP and fiber optic installations. Ideal for lay-in or pull-through installations. Available in ivory (40N2F17V) or white (40N2F17WH).

### 40N2F19 Radiused Full Capacity External Elbow

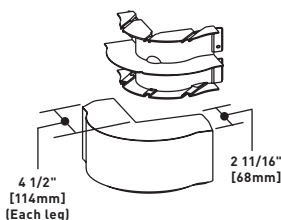

A 90° external corner with integral dividers to provide 2" [51mm] cable bend radius for UTP and fiber optic installations. Ideal for lay-in or pull-through installations. Available in ivory (40N2F19V) or white (40N2F19WH).

### 40N2F20 Blank End Fitting

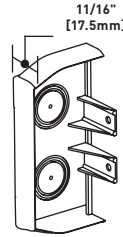

Closes off raceway end runs. Can be used to feed raceway using 1/2" or 3/4" trade size conduit. Holes for conduit must be drilled. Use a step drill or other means. Available in ivory (40N2F20V) or white (40N2F20WH).

### 40N2F21 Divided Entrance End Fitting

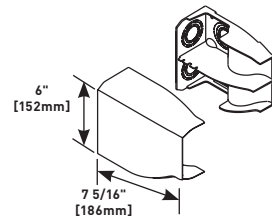

FiberReady divided fitting to feed 40N2 Series Raceway. Includes 3/4", 1", 1 1/4", and 1 1/2" trade size KOs on back and top. Available in ivory (40N2F21V) or white (40N2F21WH).

### 40N2F31 Twin Cover Device Bracket

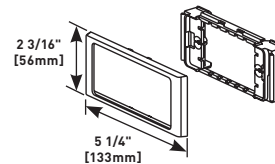

Used for power or communications devices in a single compartment. Accepts 5507 Series™ Faceplates. For use with Ortronics® TracJack Individual Jack System, Ortronics® Series II Front-Loading, Module System

Wiremold Open System Communication Modules. Available in ivory (40N2F31V) or white (40N2F31WH).

**NOTE:** CM-EPLA End Plates are required when using Wiremold communication modules and Pass & Seymour® inserts. S2-EPL End Plates are required when using Ortronics® Series II inserts. To mount TracJack inserts, use 5507-4TJ or 5507-6TJ Faceplates.

### 40N2F55 High Capacity Device Box

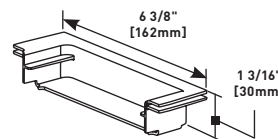

Required for mounting power or datacom devices into a divided raceway application. One used per device location.

### 40N2F74 Divided Transition Fitting

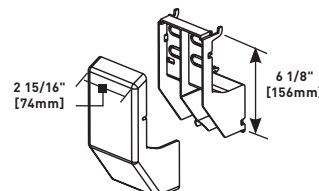

Makes transition from 40N2 Series Raceway to PN03, PN05, and PN10 Series Raceways. Available in ivory (40N2F74V) or white (40N2F74WH).

## 40N2 & 60N2 Series Nonmetallic Raceway Systems



The 40N2 and 60N2 Series Raceways from The Wiremold Company provide wire and cable management for data, voice, video, and power applications. For school and office applications these are highly aesthetic solutions for providing flexibility and accessibility to wire and cable.



*60N2 Series Raceway featuring 60N2F32 and 40N2F31 Device Brackets in a classroom application.*

### Features & Benefits

- **FiberReady™ 2" [51mm] fiber optic radius fittings.** The FiberReady Series of fittings snap on to overlap raceway base and cover for an aesthetic installation. Fittings are cULus verified for a 2" [51mm] bend radius and exceed the recommendations of TIA/EIA-569. They provide cable protection in lay-in and pull-through cable installations.
- **Twin covers for 60N2 Series.** Complete segregation of access to power and low voltage services for installation flexibility.
- **Made of PVC material.** Lightweight and easy to cut. Meets UL flammability requirements. UL Listed for up to 600V.
- **High capacity device box option.** 60N2F55 C-Box allows both power and data devices to be installed in the power channel, greatly increasing cable fill capacity for data cabling in data channel.
- **Datacom connectivity options.** Accepts industry standard and proprietary devices from a wide range of manufacturers to provide a seamless and aesthetically pleasing interface for voice, data, audio, and video applications at the point of use.
- **Ivory and white finish.** Blends with any decor. Paintable using latex paint.
- **Corner drop feed.** Provides aesthetically pleasing solution for feeding horizontal runs of raceway.
- **cULus Listed raceway.** Listed by Underwriters Laboratories Inc. for U.S. and Canadian safety standards.
- **Extremely tamper-resistant.** Perfect for school applications or anywhere additional security is a priority.



*60N2 Series Raceway featuring 40N2F31 Device Bracket and 60N2F55 Offset C-Box.*



*40N2 Series Raceway featuring 40N2F31 Device Bracket.*

## 40N2 Series Raceway Fittings

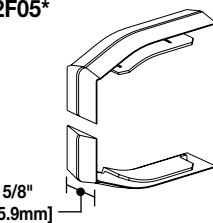
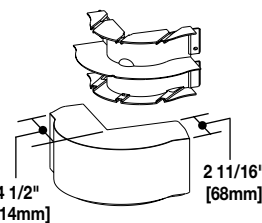
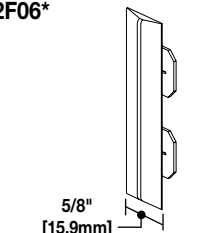
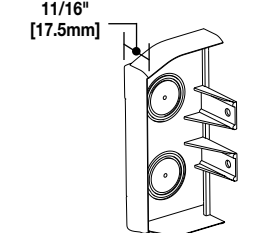
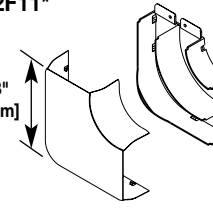
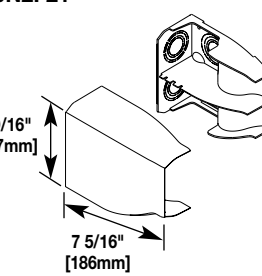
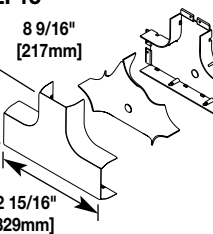
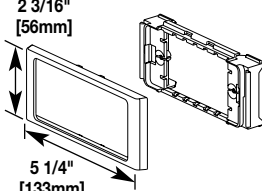
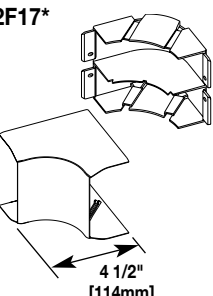
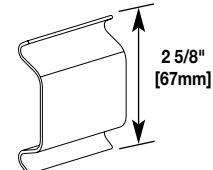
Catalog No./Item	Description/Specifications	Catalog No./Item	Description/Specifications
40N2F05*	 <p><b>Base Clip</b> – Covers seam between sections of 40N2B08 40N2B08 Base.</p> <p>5/8" [15.9mm]</p>	40N2F19*	 <p><b>FiberReady 2" [51mm] Radius Full Capacity External Elbow</b> – A 90° external corner with integral dividers to provide 2" [51mm] cable bend radius for <b>fiber optic installations</b>.</p> <p>4 1/2" [114mm]      2 11/16" [68mm]</p>
40N2F06*	 <p><b>Cover Clip</b> – Covers seam between sections of 40N2C08 Cover.</p> <p>5/8" [15.9mm]</p>	40N2F20*	 <p><b>End Cap</b> – Closes off raceway end runs. Can be used to feed raceway using 1/2" or 3/4" trade size conduit. Holes for conduit must be drilled. Use a step drill or other means.</p> <p>11/16" [17.5mm]</p>
40N2F11*	 <p><b>FiberReady 2" [51mm] Radius Full Capacity Flat Elbow</b> – A 90° flat corner with integral dividers to provide 2" [51mm] cable bend radius for <b>fiber optic installations</b>. Ideal for lay-in or pull-through installations.</p> <p>6 5/8" [168mm]</p>	40N2F21*	 <p><b>Divided Entrance End</b> – FiberReady™ divided fitting to feed 40N2F08 Series Raceway. Includes 3/4", 1", 1 1/4", and 1 1/2" KOs on back and top.</p> <p>8 9/16" [217mm]      7 5/16" [186mm]</p>
40N2F15*	 <p><b>FiberReady 2" [51mm] Radius Full Capacity Tee</b> – For branches at right angles. A full capacity tee fitting that provides separation of services and 2" [51mm] cable bend radius for <b>fiber optic installations</b>.</p> <p>8 9/16" [217mm]      12 15/16" [329mm]</p>	40N2F31*	 <p><b>Twin Cover Device Bracket</b> – Use for power or communication devices in a single compartment. Use with either 40N2B08 or 60N2B08 Raceway. Accepts 5507 Series Faceplates.</p> <p>2 3/16" [56mm]      5 1/4" [133mm]</p>
40N2F17*	 <p><b>FiberReady 2" [51mm] Radius Full Capacity Internal Elbow</b> – A 90° internal corner with integral dividers to provide 2" [51mm] cable bend radius for <b>fiber optic installations</b>. Ideal for lay-in or pull-through installations.</p> <p>4 1/2" [114mm]</p>	<div style="border: 1px solid black; padding: 5px; width: fit-content;"> <p style="margin: 0;">ORT</p> <p style="margin: 0;">P&amp;S</p> <p style="margin: 0;">OPEN</p> </div> <p>For use with:</p> <ul style="list-style-type: none"> <li>• Ortronics TracJack Individual Jack System</li> <li>• Ortronics Series II Front-Loading, Module System</li> <li>• Pass &amp; Seymour Activate Series Front-Loading Inserts</li> <li>• Wiremold Open System Communication Modules.</li> </ul>	
40N2FWC	 <p><b>Wire Clip</b> – Use to retain cables in raceway during installation.</p> <p>2 5/8" [67mm]</p>		40N2F55

\*Add "V" suffix for Ivory or "WH" suffix for White finish.