

5400 SERIES™ RACEWAY

Large Capacity, Multiple Channel



Large capacity, multiple channel raceway. Lightweight and easy-to-cut. Ideal for power or communication installations that require multiple services.

CODE REFERENCE

Listed Raceway:

File E90378 Guide RJTX.

Complies with flammability requirements of UL-5A.

Fittings: File E90377 Guide RJYT.

Meets Article 388 of NEC.

UL Listed for up to 600V.

Meets Section 12-1600 of CEC.

5400 Series Raceway System Layout

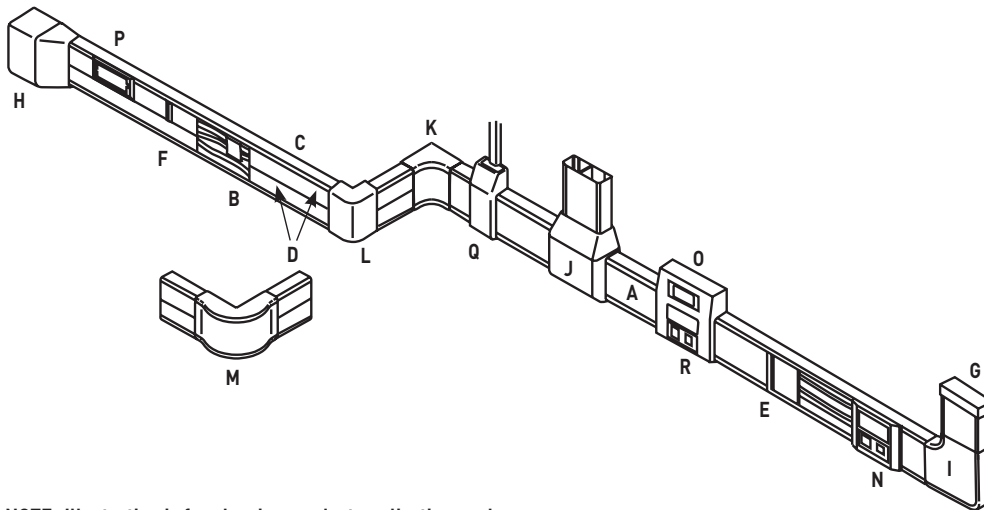

NOTE: Illustration is for showing product applications only.

KEY

- | | | |
|---------------------------------|-----------------------------------|-----------------------------------|
| A. 5400C Raceway Cover | G. 5410 Entrance End Fitting | M. 5418FO Radiused External Elbow |
| B. 5400TWC Twin Cover Wire Clip | H. 5410DFO Entrance End Feed | N. 5450 In-Line Device Bracket |
| C. 5400TB Two Compartment Base | I. 5411FO Flat Elbow | O. 5450A3 Multiple Device Bracket |
| D. 5400TC Twin Snap Cover | J. 5415 Tee | P. 5450T Twin Snap Device Bracket |
| E. 5406A Cover Clip | K. 5417FO Radiused Internal Elbow | Q. 5474 Transition Fitting |
| F. 5406T Twin Cover Seam Clip | L. 5418 Standard External Elbow | R. Communication Device |

COLOR OPTIONS



5400 Series™ Raceway Part Numbers with a "-WH" suffix have a white finish. Part Numbers without a suffix are only available in an ivory finish. 5400 Series Raceway is paintable using latex paint or stain.

Custom color options are also available. Consult the factory for more information.

5400 SERIES™ RACEWAY

Ordering Information

5406TB Base Seam Clip

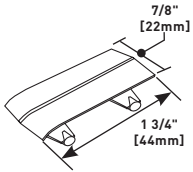

For covering joint where two pieces of 5400TB Base come together. One clip per package. Available in standard ivory (5406TB) and white (5406TB-WH).

5408L Transition Fitting

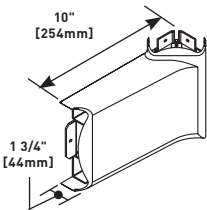

For transitioning from MXN2A08 Corner Drop to a horizontal run of 5400TB Series Raceway to the left. Available in standard ivory (5408L) and white (5408L-WH).

5408R Transition Fitting

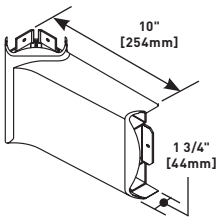

For transitioning from MXN2A08 Corner Drop to a horizontal run of 5400TB Series Raceway to the right. Available in standard ivory (5408R) and white (5408R-WH).

5410 Blank End Fitting

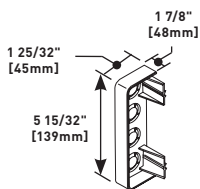

For closing open end of 5400 Series Raceway. Has four 1/2" trade size KOs for end feed. Available in standard ivory (5410) and white (5410-WH).

5410DFO Radiused Divided Entrance End Cap

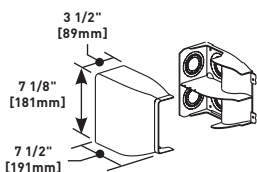

FiberReady divided fitting to feed 5400 Series Raceway. Includes 1", 1 1/4", 1 1/2", and 2" trade size KOs on back and top. Available in standard ivory (5410DFO) and white (5410DFO-WH).

5411FO Radiused Full Capacity Flat Elbow

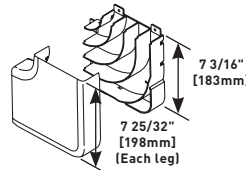

For right angle turns on the same surface. Integral dividers provide 2" [51mm] cable bend radius for UTP and fiber optic installations. Ideal for lay-in or pull-through installations. Available in standard ivory (5411FO) and white (5411FO-WH).

5415 Tee

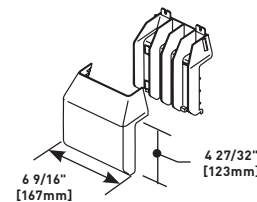

For branching raceway at right angles. Available in standard ivory (5415) and white (5415-WH).

5415FO Radiused Full Capacity Tee

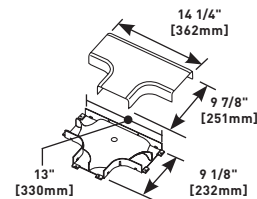

A full capacity tee fitting for branching raceway at right angles. Provides separation of services and 2" [51mm] cable bend radius for UTP and fiber optic installations. Available in standard ivory (5415FO) and white (5415FO-WH).

5417FO Radiused Full Capacity Internal Elbow

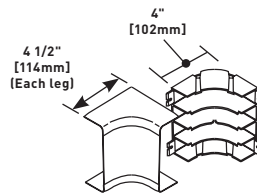

For right angle turns around internal corners. Integral dividers provide 2" [51mm] cable bend radius for UTP and fiber optic installations. Ideal for lay-in or pull-through installations. Available in standard ivory (5417FO) and white (5417FO-WH).

5418 External Elbow

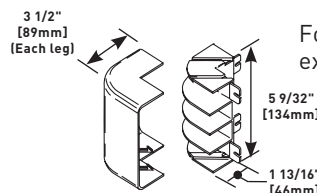

For right angle turns around external corners.