

EVOLUTION™ SERIES FLOOR BOXES



Wiremold® Evolution™ Series Floor Boxes are the latest advancement in the most complete and innovative line of floor solutions in the industry.



CODE REFERENCE

cULus Listed
Metallic Outlet Boxes:
 File E2961 Guide QCIT.
 Meets Article 314.27(C) of NEC.

Evolution™ Series Floor Box Components

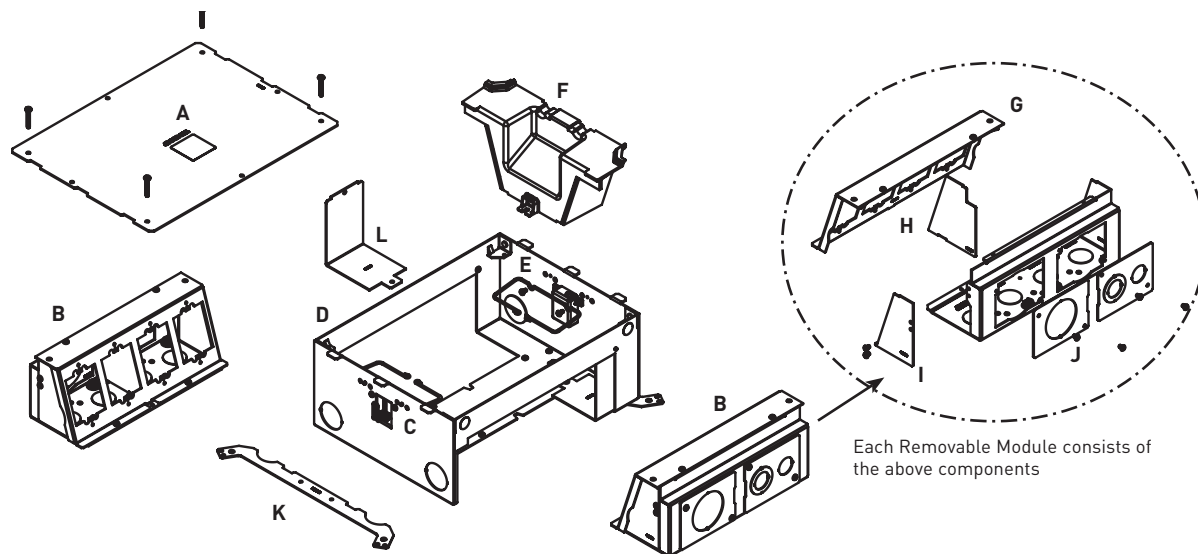

KEY

- | | |
|---|---------------------------------------|
| A. Mud Cap (temporary construction cover) | G. Mounting Bracket |
| B. Removable Module | H. Divider (removable repositionable) |
| C. Toggle Clamp | I. End Cap |
| D. Box | J. Back Knockout Plate |
| E. Cable Guide | K. Concrete Level Leg |
| F. Tunnel | L. "L" Bracket |

All items shown above are included with Evolution Series floor boxes.

COLOR OPTIONS



Evolution Series Floor Box Covers are available in the following powder coated finishes: "BK" black, "GY" gray, "NK" nickel, "BS" brass, and "BZ" bronze.

Custom color options are also available. Consult the factory for more information.

EVOLUTION™ SERIES FLOOR BOXES

Evolution™ Series 8-Gang Floor Box Accessories Ordering Information (continued)

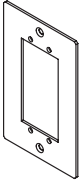
EFB-AAP Device Plate

Holds two (2) Extron® Electronics AAP devices. Device plate dimensions: 2 3/4" x 4 1/2" [69mm x 114mm].

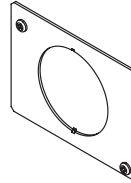
EFB810-2 Knockout Plate

Has one 2" trade size knockout.

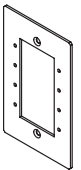
EFB-MAAP Device Plate

Holds four (4) Extron® Electronics MAAP devices. Device plate dimensions: 2 3/4" x 4 1/2" [69mm x 114mm].

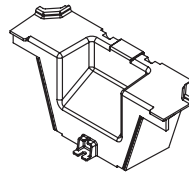
EFB810-TUN Tunnel

For EFB8 Series and EFB10 Series boxes. Tunnel allows cables to be wrapped around box from one module to the other.

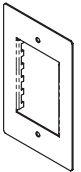
EFB-MOS Device Plate

European device plate accepts up to [45mm x 67.5mm] Arteor device. Device plate dimensions: 2 3/4" x 4 1/2" [69mm x 114mm].

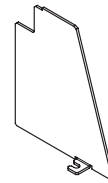
EFB810-DIV Relocatable Divider

Provides separation of services. Includes one (1) divider plate.

EFB-B Blank Device Plate

Device plate dimensions: 2 3/4" x 4 1/2" [69mm x 114mm].

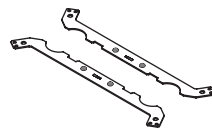
EFB-CLL Concrete Leveling Legs

Concrete Leveling Legs – Legs allow floor box to be adjusted up or down to match the desired pour height of the concrete. Includes two (2) leveling legs. Threaded rod not supplied.

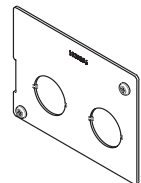
EFB810-3/4-3/4 Knockout Plate

Has two (2) 3/4" trade size knockouts.

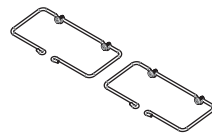
EFBCMG Cable Management Guides

Guides help organize and maintain cable position when opening and closing the cover.

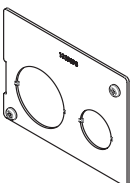
EFB810-3/4-11/4 Knockout Plate

Has one 3/4" and one 3/4"/1 1/4" concentric trade size knockout.

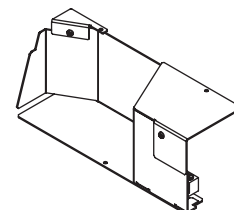
EFB-50A 50A Adapter

Allows for a 50A device to be installed on the 8-gang and 10-gang series boxes.

NOTE: Only fits on the side of the floor box where the device is facing the tunnel.

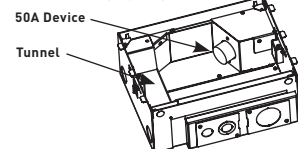

EVOLUTION™ SERIES FLOOR BOXES

Evolution™ Series 10-Gang Floor Box Accessories Ordering Information (continued)

EFB810-TUN Tunnel

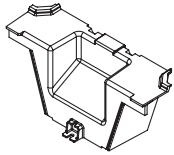

For EFB8 Series and EFB10 Series boxes. Tunnel allows cables to be wrapped around box from one module to the other.

EFBCMG Cable Management Guides

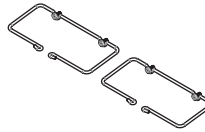

Guides help organize and maintain cable position when opening and closing the cover.

EFB810-DIV Relocatable Divider

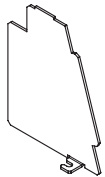

Provides separation of services. Includes one (1) divider plate.

EFB-50A 50A Adapter

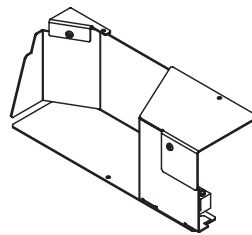

Allows for a 50A device to be installed on the 8-gang and 10-gang series boxes.

NOTE: Only fits on the side of the floor box where the device is facing the tunnel.

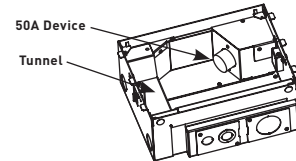

EFB-CLL Concrete Leveling Legs

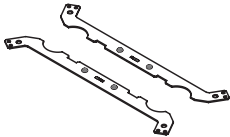

Legs allow floor box to be adjusted up or down to match the desired pour height of the concrete. Includes two (2) leveling legs. Threaded rod not supplied.

Evolution™ Series Floor Box Cover Plates & Accessories Ordering Information

EFB610CTC Surface Style Cover with Carpet Insert

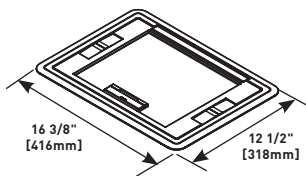

EFB610CTCBK, EFB610CTCGY, EFB610CTCBS, EFB610CTCNK, EFB610CTCBZ

Die cast aluminum cover assembly designed to be used on top of the floor covering. Available in the following powder coated finishes: black, gray, brass, nickel and bronze. For use on Evolution™ Series 6-, 8- and 10-gang floor boxes (EFB6, EFB8 and EFB10).

NOTE: Depth of recess area in plate is 1/4" [6.35mm].

EFB610CT Flush Style Cover with Carpet Insert

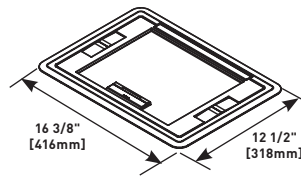

EFB610CTBK, EFB610CTGY, EFB610CTBS, EFB610CTNK, EFB610CTBZ

Die cast aluminum cover assembly designed to be used level (flush) with finish floor covering. Available in the following powder coated finishes: black, gray, brass, nickel and bronze. For use on Evolution™ Series 6-, 8- and 10-gang floor boxes (EFB6, EFB8 and EFB10).

NOTE: Depth of recess area in plate is 1/4" [6.35mm].