

EVOLUTION™ SERIES FLOOR BOXES



Wiremold® Evolution™ Series Floor Boxes are the latest advancement in the most complete and innovative line of floor solutions in the industry.



CODE REFERENCE

cULus Listed
Metallic Outlet Boxes:
 File E2961 Guide QCIT.
 Meets Article 314.27(C) of NEC.

Evolution™ Series Floor Box Components

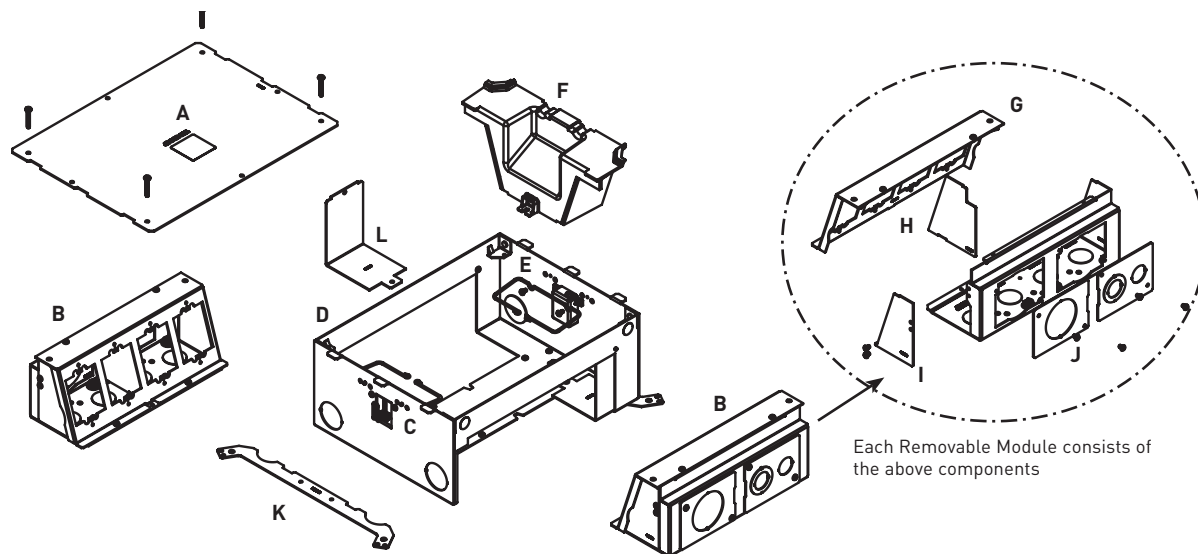

KEY

- | | |
|---|---------------------------------------|
| A. Mud Cap (temporary construction cover) | G. Mounting Bracket |
| B. Removable Module | H. Divider (removable repositionable) |
| C. Toggle Clamp | I. End Cap |
| D. Box | J. Back Knockout Plate |
| E. Cable Guide | K. Concrete Level Leg |
| F. Tunnel | L. "L" Bracket |

All items shown above are included with Evolution Series floor boxes.

COLOR OPTIONS



Evolution Series Floor Box Covers are available in the following powder coated finishes: "BK" black, "GY" gray, "NK" nickel, "BS" brass, and "BZ" bronze.

Custom color options are also available. Consult the factory for more information.

EVOLUTION™ SERIES FLOOR BOXES

Evolution™ Series 10-Gang Floor Box Accessories Ordering Information (continued)

EFB10-MOS Device Plate

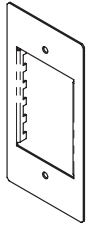

[45mm x 67.5mm] device plate. Device plate dimensions: 2.3" x 4.652" [58mm x 118mm].

5507B-WH Blank Faceplate

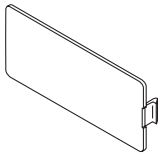

For covering unused compartments in the device bracket.

5507D-WH Duplex Receptacle Faceplate

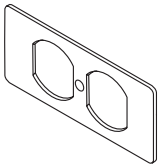

For covering duplex style devices. Accepts 106 frame.

5507R-WH Rectangular Receptacle Faceplate

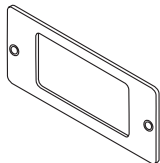

For covering rectangular decorator style devices.

5507S-WH Rectangular Spacer

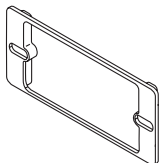

For mounting commercial device plates. Installs between the device bracket and a device.

5507T1-WH Single Receptacle Faceplate

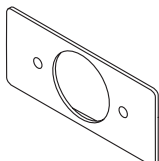

For covering single receptacles – 1.59" [40mm] in diameter.

5507T2-WH Single Receptacle Faceplate

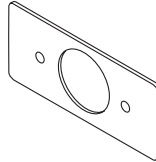

For covering single receptacles – 1.41" [36mm] in diameter.

55074TJ-WH Ortronics® Faceplate

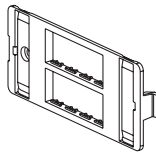

For mounting Ortronics® datacom inserts. Accepts four (4) TracJack devices.

55076TJ-WH Ortronics® Faceplate

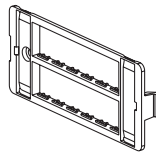

For mounting Ortronics® datacom inserts. Accepts six (6) TracJack devices.

EFB810-3/4-3/4 Knockout Plate

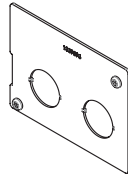

Has two 3/4" trade size knockout.

EFB810-3/4-11/4 Knockout Plate

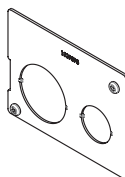

Has one 3/4" and one 3/4"/1 1/4" concentric trade size knockout.

EFB810-2 Knockout Plate

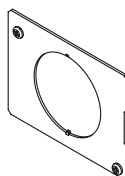

Has one 2" trade size knockout.