

2400D[®] SERIES RACEWAY



Dual channel version of 2400 Series Raceway. Easy-to-install and ideal for basic power and communication/low voltage installations in classrooms, hotels, and anywhere a low profile raceway solution is needed.

CODE REFERENCE

cULus Listed Raceway:
File E4376 Guide RJBT.

Fittings:
File E41751 Guide RJPR.
Meets Article 386 of NEC.
Meets Section 12-1600 of CEC.

2400D Series Raceway System Layout for Power & Data

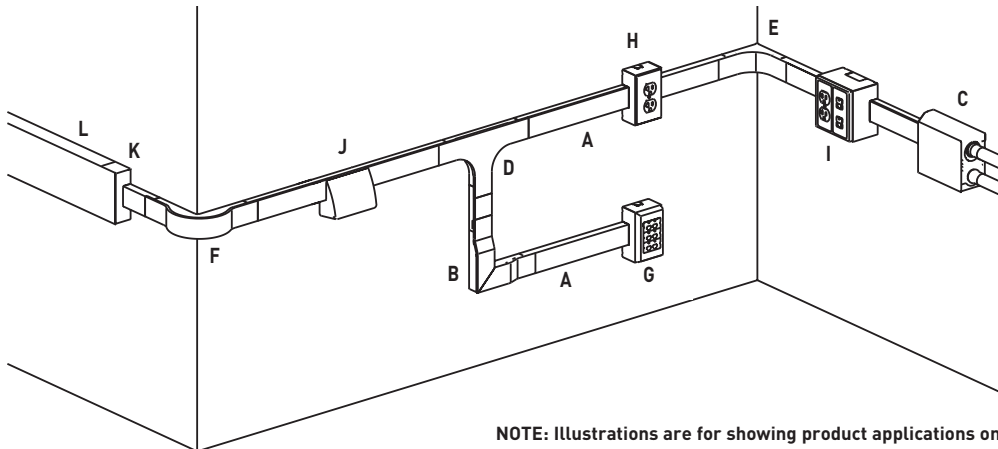

NOTE: Illustrations are for showing product applications only.

KEY

- | | |
|--|--|
| A. 2400D 2400 Series Divided Raceway | H. 2444D One-Gang Device Box |
| B. 2411DFO Radiused Divided Flat Elbow | I. 2444D-2A Two-Gang Divided Device Box |
| C. 2410DFO Divided Entrance End Fitting | J. 24DWND Downward Duplex Device Bracket |
| D. 2415DFO Radiused Divided Tee | 24DWNR Downward Decorator Device Bracket |
| E. 2417DFO Radiused Divided Internal Elbow | K. 4089 Reducing Connector |
| F. 2418DFO Divided External Elbow | L. U4000 Series Raceway |
| G. 2444 One-Gang Extra Deep Device Box | |

COLOR OPTIONS



2400 Series™ Raceway Part Numbers with a "V" prefix have an ivory finish. Part Numbers with a "-FW" suffix have a fog white finish.

Custom color options are also available. Consult the factory for more information.

2400D SERIES™ RACEWAY

2400D Series Raceway Fittings Ordering Information (continued)

V2475D, 2475D-FW Bridge Fitting

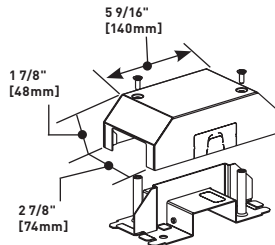

Allows 2400D Series Raceway runs to bridge over existing installations of 2400, 2400D, 500, and 700 Series Raceways.

IWE-S, DVWE-S Spray Paint



Used for touching up large areas. Contains 12 oz. of paint. Available in ivory (IWE-S) and fog white (DVWE-S).

NOTE: Can only be shipped via ground transportation

V4089 Reducing Connector

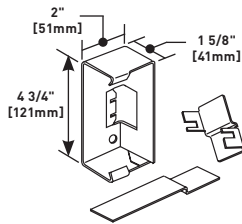

Connects 4000 Series Raceway to 2400D Series Raceway.

IWE-P, DVWE-P Touch-Up Paint Pen



Used for touching up small areas. Contains 0.3 oz. of paint. Available in ivory (IWE-P) and fog white (DVWE-P).

5507 Series Faceplates Ordering Information

5507AD, 5507AD-FW Modular Furniture Adapter

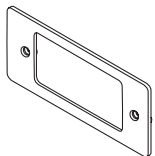

Covers Activate modular furniture adapter and other modular furniture adapters. Not for use with decorator (rectangular) style devices.

5507R, 5507R-FW Rectangular Faceplate

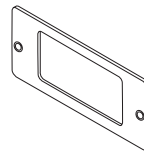

Covers rectangular decorator style devices.

5507B, 5507B-FW Blank Faceplate

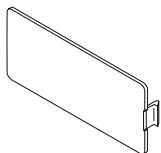

Covers unused compartments in the device bracket.

5507SW, 5507SW-FW Switch Faceplate

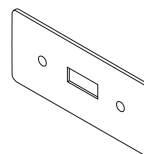

Covers standard toggle switches.

5507D, 5507D-FW Duplex Faceplate

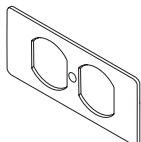

Covers duplex style devices including 106 Frame.

5507T1, 5507T1-FW Single Receptacle Faceplate

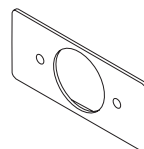

Covers single receptacles 1.59" [40.4mm] diameter.

5507 SERIES™ FACEPLATES

Ordering Information



5507 Series™ Faceplates accept a wide assortment of power, A/V and datacom devices from leading manufacturers. Faceplates can be used in nonmetallic device brackets for 2300BACD, 400BAC, 5000, 5400TB, 5500BD3, 40N2 Series Raceways, 4050 Device Bracket for Steel Raceways, and WallSource™ Boxes.

NOTE: All 5507 Series™ Faceplates have a standard measurement of 4 1/4" x 1 7/8" [108mm x 34mm].

CODE REFERENCE

Listed Raceway:

File E90378 Guide RJTX.

Complies with flammability requirements of UL-5A.

Fittings: File E90377 Guide RJYT.

Meets Article 388 of NEC.

UL Listed for up to 600V.

Meets Section 12-1600 of CEC.

COLOR OPTIONS



5507 Series™ faceplate Part Numbers without a suffix are available in an ivory finish. Part Numbers with a "-WH" suffix have a white finish. Part Numbers with a "-G" suffix have a gray finish. Part Numbers with a "-BK" suffix have a black finish. Part Numbers with a "-FW" suffix have a fog white finish. Part numbers with a "-GY" suffix have a light gray finish.

5507 Series Faceplates Ordering Information

5507AD Modular Furniture Adapter

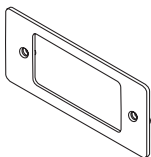

For mounting Activate and other modular furniture bezels and other modular furniture adapters. Not for use with rectangular (decorator) style devices. Available in ivory (5507AD), white (5507AD-WH), gray (5507AD-G) and fog white (5507AD-FW).

5507D Duplex Receptacle Faceplate

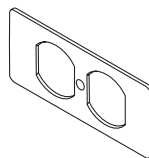

For covering duplex style devices. Accepts 106 Frame. Available in ivory (5507D), white (5507D-WH), gray (5507D-G), black (5507D-BK), light gray (5507D-GY) and fog white (5507D-FW).

5507B Blank Faceplate

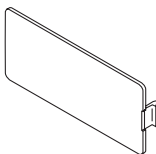

For covering unused compartments in the device bracket. Available in ivory (5507B), white (5507B-WH), gray (5507B-G), light gray (5507B-GY) and fog white (5507B-FW).

5507FRJ Flush Dual RJ Connector Faceplate

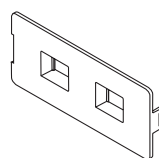

For mounting one or two keystone device modules, recessed to provide a flush installation. Has one opening and one KO. Available in ivory (5507FRJ), white (5507FRJ-WH), gray (5507FRJ-G), light gray (5507FRJ-GY) and fog white (5507FRJ-FW).