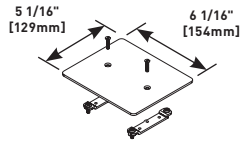
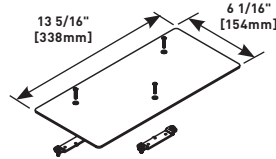

WALKERDUCT® PRO SERIES SERVICE FITTINGS

Walkerduct Pro Series Trim Plates and Accessories Ordering Information

430 Single Blanking Plate

Brass (430BR) or aluminum (430AL) plate to cover single Walkerduct Pro Series Presets.

432 Triple Blanking Plate

Brass (432BR) or aluminum (432AL) plate to cover three Walkerduct Pro Series Presets.

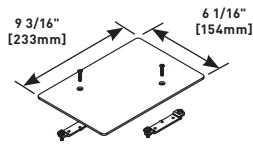
431 Double Blanking Plate

Brass (431BR) or aluminum (431AL) plate to cover two Walkerduct Pro Series Presets.

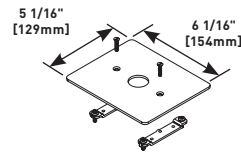
430075 Single Trim Plate

Brass (430BR075) or aluminum (430AL075) plate with opening for 3/4" trade size conduit or liquidtight connection. Fits over single Walkerduct Pro Series Preset.

Trim Plates and Accessories Ordering Information

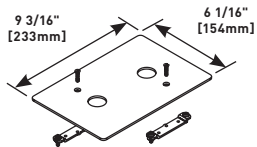
431075 Double Trim Plate

Brass (431BR075) or aluminum (431AL075) plate with opening for 3/4" trade size conduit or liquidtight connection. Fits over two Walkerduct Pro Series Presets.

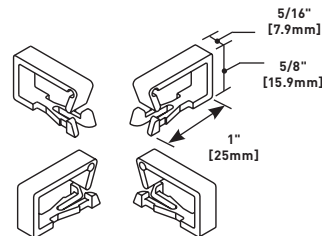
427 Fiber Loop Kit

Nonmetallic clips snap into tabs in preset base. Hold up to one meter of cable. Maintain 1 1/4" [32mm] bend radius. Four clips included in kit.

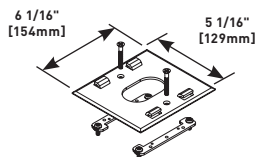
430S505 Single 525 Trim Plate

Aluminum plate with opening to attach 525 Series Service Fitting Housing. Fits over single Walkerduct Pro Series Preset.

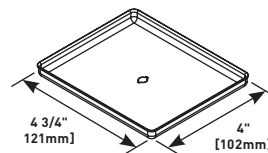
421 Mudcap

Steel mudcap for Walkerduct Pro Series Preset.

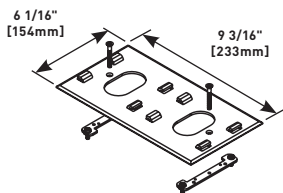
431D505 Double 525 Trim Plate

Aluminum plate with openings to attach two 525 Series Service Fitting Housings. Fits over two Walkerduct Pro Series Presets.

WALKERDUCT® UNDERFLOOR DUCT SYSTEMS



Walkerduct® Underfloor Duct Systems offer maximum capacity and configurability using two sizes of duct.

CODE REFERENCE

ULus Listed Underfloor Raceway:
File E7020 Guide RKCZ

cULus Listed Underfloor Raceway Fittings:
File E11912 Guide RKQX.
Meets Article 390 of NEC.

Walkerduct Pro Series System Layout with Junction Boxes

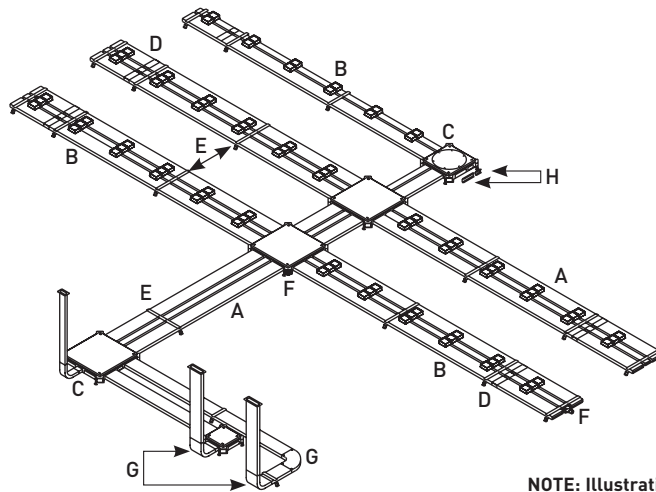

KEY

- A. Duct
- B. Pro Series Preset
- C. Junction Box
- D. Coupling
- E. Duct Support
- F. Conduit Adapter
- G. Elbow
- H. Junction Box Closure

NOTE: Illustration is for showing product applications only.

Walkerduct 2" [51mm] IPS Duct System Layout with Trenchduct

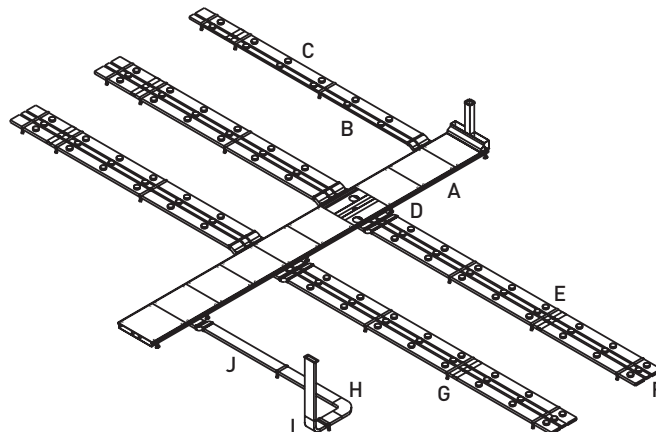

KEY

- A. Trenchduct
- B. #2 2" IPS Duct
- C. #4 2" IPS Duct
- D. Cross Under
- E. Couplings
- F. End Closure
- G. Duct Support
- H. Horizontal Flat Elbow
- I. Vertical Elbow
- J. Blank #4 Duct

NOTE: Illustration is for showing product applications only.

WALKERDUCT® UNDERFLOOR DUCT SYSTEMS

Walkerduct Duct Accessories Ordering Information

SC12 Adjustable Duct Supports with Built-in Coupling

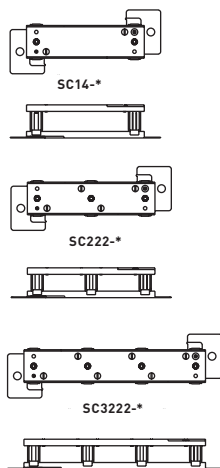

SC14, SC222, SC224, SC244, SC3222, SC3224, SC3244, SC3424

To support, couple, and hold duct in place before and during concrete pour. Steel construction. Leveling screws provide vertical adjustment. Different leg heights available. Supports may be fastened to form or to slab through holes in the feet. Top members maintain 1" [25mm] spacing between ducts. Locate duct supports on approximately 5' [1.5m] intervals.

*CATALOG NO. SUFFIX	HEIGHT ADJUSTMENT
-18	1/2" [12.7mm] to 1 7/8" [48mm]
-33	1 1/2" [38mm] to 3 3/4" [95mm]
-48	3" [76mm] to 4 7/8" [124mm]

Duct supports for deeper pours are available through the factory.

How to Determine Correct Support Heights

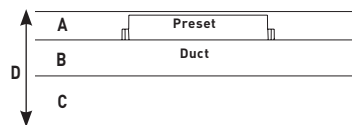

- A Height of preset.
- B Height of duct.
- C Distance from bottom of duct to form or slab. This dimension is the correct support height.
- D Distance between finished concrete floor line and floor slab. This dimension is the sum total of A, B, and C. Support Height (C) = D - (A and B)

HS12 Hold-Down Straps

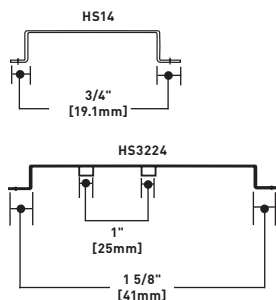

HS14, HS222, HS224, HS244, HS3222, HS342, HS3244

To fasten ducts to the slab in shallow concrete. Used in place of duct supports. Straps maintain 1" [25mm] spacing between ducts on multiple duct runs and prevent duct from floating during concrete pour. Attaches to slab with stakes or drive pins (not included). Locate Hold-Down Straps on

approximate 5' [1.5m] centers. Duct systems with both #2 and #4 ducts will require a 1/4" thick shim to bring the top of the #2 duct level with the #4 duct. Consult factory for additional information.

NOTE: Steel shims (Cat. # Duct Shims) should be placed under #2 Duct to maintain proper preset height.

421 Pro Series Mudcap

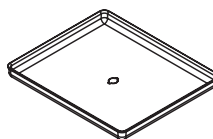

Steel replacement cap for preset or afterset. Recessed to hold 3/8" [9.5mm] concrete.

422GR, 422RD Pro Series Marker Cap

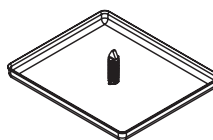

Replaces mudcap on preset to indicate location of the last insert in each run. Select color for each service.

425, 426 Preset Extensions

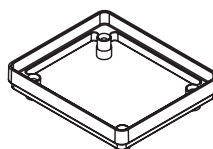

1/2" [12.7mm] [425] and 1" [25mm] [426] Preset Extensions. Steel replacement cap for preset or afterset. Recessed to hold 3/8" [9.5mm] concrete.

D2075, D4075 Duct Conduit Hub

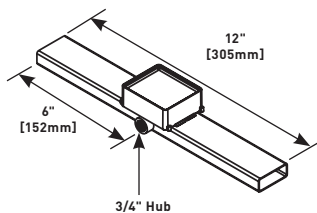

D2075 for No. 2 Duct, D4075 for No. 4 Duct. 12" [305mm] section of Duct with 1" [25mm] Preset. For rigid or PVC conduit. Used to provide feed to isolated outlets; maintains 12" [305mm] spacing of presets. Preset height is 1" [25mm]. Add extensions if higher preset needed.

404 2" [51mm] IPS Duct Mudcap

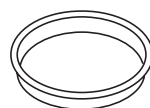

Steel replacement cap for 2" [51mm] IPS preset. Recessed to hold 3/8" [9.5mm] concrete.

415B, 415N 2" [51mm] IPS Duct Marker Cap

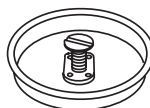

Replaces mudcap on preset to indicate location of run. NEC requires markers to locate the last preset in each run. Select color for each service. Available in brass (B) or steel (N).